



SERVOMOTOR VOLTAGE STABILISER

EMi3

General index

1. INTRODUCTION.

1.1. ACKNOWLEDGEMENT LETTER.

2. INFORMATION FOR SAFETY.

2.1. USING THIS MANUAL.

2.1.1. Conventions and used symbols.

3. QUALITY AND STANDARD GUARANTEE.

3.1. DECLARATION OF THE MANAGEMENT.

3.2. STANDARD.

3.3. ENVIRONMENT.

4. PRESENTATION.

4.1. VIEWS.

4.1.1. Equipment views.

4.1.2. Legends corresponding to the equipment views.

4.2. DEFINITION OF THE PRODUCT.

4.2.1. Nomenclature.

4.3. PRESENTATION.

4.4. DESCRIPTION OF THE EQUIPMENT.

4.5. MAIN QUALITY PERFORMANCES.

4.6. OPERATING PRINCIPLE

4.7. OPTIONS

4.7.1. Measurement of output currents, powers and overload.

4.7.2. Maximum-minimum output voltage protection.

4.7.2.1. Manual/Automatic operating.

4.7.3. Bypass Manual.

4.7.4. Overload contactor.

4.7.5. Non-critical loads contactor.

4.7.6. Communication and dry contacts module.

4.7.7. Budget version of the dry contacts to terminals.

4.7.8. Slot for SICRES Ethernet communication card.

4.7.9. Galvanic isolation transformer.

4.7.10. Other regulation ranges.

4.7.11. External manual Bypass panel.

5. INSTALLATION.

5.1. TO CONSIDER IN THE INSTALLATION.

5.2. EQUIPMENT RECEPTION.

5.2.1. Unpacking, inspection and contents checking.

5.2.2. Storage.

5.2.3. Unpacking.

5.2.4. Transport till its location.

5.2.5. Location.

5.3. CONNECTION.

5.3.1. Connection of input terminals.

5.3.2. Connection of output terminals.

5.3.3. Non-critical loads connection.

5.3.4. Connection of the protective earth .

5.3.5. Connection of the communication module.

5.3.6. Connection of the budget dry contacts option to terminals.

5.3.7. SICRES Ethernet communication card.

5.3.8. Connection between an external manual Bypass Panel, stabilizer and loads.

6. OPERATING.

6.1. CONTROLS BEFORE COMMISSIONING.

6.2. START UP AND SHUTDOWN OF THE STABILIZER.

6.2.1. First commissioning procedure.

6.2.1.1. Procedure

6.2.2. Start up.

6.2.3. Shutdown of the stabilizer.

6.3. BYPASS MANUAL, OPTION.

6.3.1. Load power supply from mains through the manual Bypass.

6.3.2. Supply the loads through the stabilizer.

6.4. MANUAL BYPASS PANEL, OPTION.

6.4.1. Supply the loads from mains with the manual Bypass panel.

6.4.2. Supply the loads from the stabilizer.

7. CONTROL PANEL.

7.1. LED OPTIC INDICATORS AND ALARM.

7.2. BASIC FUNCTIONS OF THE KEYS AND NOTES.

7.3. DESCRIPTION OF THE SCREENS.

7.3.1. «Start» screen menu.

7.3.2. «Measures» menu.

7.3.3. «Operation» menu.

7.3.4. «Alarm» menu.

7.3.5. «Parameter selection» menu.

7.3.6. «Password» menu.

8. MAINTENANCE, WARRANTY AND SERVICE.

8.1. BASIC TROUBLESHOOTING GUIDE FOR PREVENTIVE MAINTENANCE.

8.1.1. Annual inspection.

8.1.1.1. General.

8.1.1.2. Brushes.

8.1.1.3. Advices.

8.1.1.4. Particular cases.

8.2. WARRANTY CONDITIONS.

8.2.1. Warranty terms.

8.2.2. Out of scope of supply.

8.3. TECHNICAL SERVICE NETWORK.

9. ANNEXES.

9.1. STANDARD EQUIPMENTS GENERAL TECHNICAL SPECIFICATIONS.

1. INTRODUCTION.

1.1. ACKNOWLEDGEMENT LETTER.

We would like to thank you in advance for the trust you have placed in us by purchasing this product. Read this instruction manual carefully in order to be familiarized with its contents, because, as much as you know and understand the equipment the highest will be your satisfaction and safety levels and their features will be optimized too.

We remain at your entire disposal for any further information or any query you should wish to make.

Yours sincerely.

- The equipment here described **can cause important physical damages due to wrong handling**. This is why, the installation, maintenance and/or fixing of itself must be done by our staff or qualified **personnel exclusively**.
- Although we have made every effort to guarantee a complete and accurate information in this user's manual, we are not responsible for any errors or omissions that may exist.
The images included in this document are mere illustrations and they could not represent the part of the equipment exactly, therefore they are not contractual. Nevertheless, differences that could exist will be alleviated or solved with the correct labelling of the equipment.
- According to our policy of constant evolution, **we reserve the right to modify the specifications, operating or described actions in this document without forewarning**.
- **Any reproduction, copy or third party concession, modification or partial or in whole translations** of this manual or document, in any format or media, **is prohibited without the previous written authorization of our firm**, being reserved the full and exclusive ownership right over it.

2. INFORMATION FOR SAFETY.

2.1. USING THIS MANUAL.

The generic information of the equipment is supplied in digital format in a CD-ROM, and it includes among other documents the own user's manual of the system and the EK266*08 document concerning to **«Safety instructions»**. Before doing any action over the equipment regarding installation or commissioning, change of location, setting or handling, read them carefully.

This user's manual is intended to provide information regarding the safety and to give explanations about the procedures for the installation and operating of the equipment. Read them carefully and follow the stated steps in the established order.



Compliance as regards to “Safety instructions” is mandatory, being the user the legal responsible regarding to its observance and application.

The equipments are delivered duly labelled for the correct identification of any their parts, which combined with the instructions described in this user's manual, allows the end-user to make any operating of both installation and commissioning, in an easy and ordered way without doubt. When an equipment differs from the one shown in figures of section 4, additional annexes will be edited if they were deemed appropriate or necessary. Generally, they will be delivered in hardcopy.

Finally, once the equipment is installed and operative, for future requests or doubts that could arise, it is recommended to keep the CD-ROM documentation in a safe place with easy access.

The following terms are used in the document indistinctly to be referred to:

- **«EMi3, equipment, stabilizer, voltage stabilizer or unit»**.- Servomotor voltage equipment stabilizer.
- **«T.S.S.»**.- Technical Service and Support.
- **«client, fitter, operator or end-user»**.- are used indistinctly and by extension, to be referred to the fitter and/or operator which will make the corresponding actions, being responsible the same person about the actions to take on behalf of himself.
- In case of installations with IT neutral regime, the switches, circuit breakers must break the NEUTRAL a part from the three lines.

2.1.1. Conventions and used symbols.

Some symbols can be used and shown in the equipment and/or in the description of this user's manual.

For more information, see section 1.1.1 of EK266*08 document as regards to **«Safety instructions»**.

3. QUALITY AND STANDARD GUARANTEE.

3.1. DECLARATION OF THE MANAGEMENT.

Our target is the client's satisfaction, therefore this Management has decided to establish a Quality and Environmental policy, by means of installation a Quality and Environmental Management System that becomes us capable to comply the requirements demanded by the standard ISO 9001 and ISO 14001 and by our Clients and concerned parts too.

Likewise, the enterprise Management is committed with the development and improvement of the Quality and Environmental Management System, by means of:

- The communication to all the company about the importance of satisfaction both in the client's requirements and in the legal and regulations.
- The Quality and Environmental Policy diffusion and the fixation of the Quality and Environment targets.
- To carry out revisions by the Management.
- To provide the needed resources.

3.2. STANDARD.

The **EMi3** product is designed, manufactured and commercialized in accordance with the standard **EN ISO 9001** of Quality Management Systems and certified by SGS body. The **CE** marking shows the conformity to the EEC Directive by means of the application of the following standards:

- **2014/35/EU**. - Low Voltage Directive (LVD).
- **2014/30/EU**. - Electromagnetic Compatibility (EMC).
- **2011/65/EU**. - Restriction of Hazardous Substances in electrical and electronic equipment (RoHS).

In accordance with the specifications of the harmonized standards. Standards as reference:

- **IEC/EN 62103**. - Electronic equipments for use in power installations.
- **IEC/EN 61000-6-4**. - Electromagnetic compatibility. Generic norm of emission. Industrial environment.
- **IEC/EN 61000-6-2**. - Electromagnetic compatibility. Generic norm of immunity. Industrial environment.



In case of any modification or intervention over the equipment by the end-user, the manufacturer is not responsible.



This is an equipment of class A. This equipment, in domestic environment can cause radio interferences, in such case the end-user must take the appropriate measures.



Declaration of conformity CE of the product is at the client disposal under previous request to our headquarters offices.

3.3. ENVIRONMENT.

This product has been designed to respect the Environment and manufactured in accordance with the **ISO 14001 norm**.

Equipment recycling at the end of its useful life:

Our company commits to use the services of authorised societies and according to the regulations, in order to treat the whole recovered product at the end of its useful life (contact your distributor).

Packaging:

To recycle the packaging, follow the legal regulations in force, in accordance with the particular norm of the country where the equipment is installed.

4. PRESENTATION.

4.1. VIEWS.

4.1.1. Equipment views.

Tables from 1 to 8 show the standardised models with their physical dimensions and weights, as well as the correlation with the illustrations of Fig. 1 to 11.

All models have a control panel with LCD as an interface between the equipment and the end-user, which gives information of different nature through its menus structured in categories (see section 7).

Three phase equipments consisting of three single phase cabinets, each one of them will have their own control panel.



Any figure referred to the main specifications of the equipment can be checked in the nameplate of the equipment. Act for your installation accordingly.

Model	Voltage	Power (kVA)	⁽¹⁾ Dimen. (mm) D. x W. x H.	Weight (kg)	Nr fig.
EMi3 M 5-2 ⁽⁰⁾	Single phase 220 / 230V or 240 / 240 V with input voltage range $\pm 15\%$	5	590 x 340 x 585 ⁽²⁾	45	1
EMi3 M 7,5-2 ⁽⁰⁾		7,5		59	
EMi3 M 10-2 ⁽⁰⁾		10		60	
EMi3 M 15-2 ⁽⁰⁾		15	905 x 460 x 705 ⁽²⁾	115	2
EMi3 M 20-2 ⁽⁰⁾		20		119	
EMi3 M 25-2 ⁽⁰⁾		25		196	
EMi3 M 30-2 ⁽⁰⁾		30		209	
EMi3 M 40-2 ⁽⁰⁾		40		325	
EMi3 M 65-2		65	850 x 615 x 1320	450	4
EMi3 M 100-2		100		500	
EMi3 M 150-2		150	850 x 815 x 2120	919	5
EMi3 M 200-2		200		1227	7-8
EMi3 M 250-2		250		1298	
EMi3 M 300-2		300	1450		

Tabla 1. Single phase models and input range $\pm 15\%$.

Model	Voltage	Power (kVA)	⁽¹⁾ Dimen. (mm) D. x W. x H.	Weight (kg)	Nr fig.	
EMi3 T 15-4	Three phase 3x380 V, 3x400 / 3x415 / 3x415 V with input voltage range $\pm 15\%$	15	905 x 460 x 705 ⁽²⁾	126	3	
EMi3 T 15-4F				131		
EMi3 T 20-4				169		
EMi3 T 20-4F		174				
EMi3 T 35-4		224				
EMi3 T 35-4F		229				
EMi3 T 55-4		650 x 615 x 2120	55	374	6	
EMi3 T 55-4F				379		
EMi3 T 70-4				495		
EMi3 T 70-4F		500				
EMi3 T 90-4		850 x 615 x 2120	90	533		7-9
EMi3 T 90-4F				538		
EMi3 T 110-4				577		
EMi3 T 110-4F		582				
EMi3 T 140-4F		850 x 1615 x 2120	140	857	7-9	
EMi3 T 175-4F				1159		
EMi3 T 220-4F				1227		
EMi3 T 275-4F				1298		
EMi3 T 330-4F				1450		
EMi3 T 375-4F		1642				
EMi3 T 450-4F		1870				
EMi3 T 500-4F		2820	3 single phase equipments 1650 x 815 x 2120	2820	10-11	
EMi3 T 600-4F		600		3600		
EMi3 T 800-4F		800		3900		
EMi3 T 1000-4F		1000		4350		
EMi3 T 1300-4F		1300		5610		

Tabla 2. Three phase models with input range $\pm 15\%$.

Model	Voltage	Power (kVA)	⁽¹⁾ Dimen. (mm) D. x W. x H.	Weight (kg)	Nr fig.
EMi3 M 5-2 ⁽⁰⁾	Single phase 220 / 230V or 240 / 240 V with input voltage range $\pm 20\%$	5	590 x 340 x 585 ⁽²⁾	59	1
EMi3 M 7,5-2 ⁽⁰⁾		7,5		63	
EMi3 M 10-2 ⁽⁰⁾		10	905 x 460 x 705 ⁽²⁾	115	2
EMi3 M 15-2 ⁽⁰⁾		15		125	
EMi3 M 20-2 ⁽⁰⁾		20		209	
EMi3 M 25-2 ⁽⁰⁾		25		325	
EMi3 M 30-2		30		650 x 615 x 1320	
EMi3 M 40-2		40	850 x 615 x 1320	450	
EMi3 M 65-2		65	850 x 615 x 2120	500	5
EMi3 M 100-2		100		919	
EMi3 M 150-2		150	850 x 1615 x 2120	1289	7-8
EMi3 M 200-2		200		1450	
EMi3 M 250-2		250		1692	

Tabla 3. Single phase models with input range $\pm 20\%$.

Model	Voltage	Power (kVA)	⁽¹⁾ Dimen. (mm) D. x W. x H.	Weight (kg)	Nr fig.
EMi3 T 15-4	three phase 3x380 V, 3x400 / 3x400 or 3x415 / 3x415 V with input voltage range $\pm 20\%$	15	905 x 460 x 705 ⁽²⁾	178	3
EMi3 T 15-4F				183	
EMi3 T 20-4				224	
EMi3 T 20-4F		20	905 x 460 x 705 ⁽²⁾	229	6
EMi3 T 35-4				374	
EMi3 T 35-4F		35	650 x 615 x 2120	379	6
EMi3 T 55-4				533	
EMi3 T 55-4F		55	650 x 615 x 2120	538	6
EMi3 T 70-4				577	
EMi3 T 70-4F		70	850 x 615 x 2120	582	7-9
EMi3 T 90-4F				857	
EMi3 T 110-4F		110	850 x 1615 x 2120	1159	7-9
EMi3 T 140-4F		140		1227	
EMi3 T 175-4F		175	850 x 1615 x 2120	1298	7-9
EMi3 T 220-4F		220		1450	
EMi3 T 275-4F		275	850 x 1615 x 2120	1686	7-9
EMi3 T 330-4F		330		1920	
EMi3 T 375-4F		375	3 single phase equipments 1650 x 815 x 2120	2961	10-11
EMi3 T 450-4F		450		3780	
EMi3 T 500-4F		500	3 single phase equipments 1650 x 815 x 2120	3900	10-11
EMi3 T 600-4F	600	4095			
EMi3 T 800-4F	800	3 single phase equipments 1650 x 815 x 2120	5610	10-11	
EMi3 T 1000-4F	1000		8460		

Tabla 4. Three phase models with input range $\pm 20\%$.

Model	Voltage	Power (kVA)	⁽¹⁾ Dimen. (mm) D. x W. x H.	Weight (kg)	Nr fig.
EMi3 M 5-2 ⁽⁰⁾	Single phase 220 / 230V or 240 / 240 V with input voltage range $\pm 25\%$	5	590 x 340 x 585 ⁽²⁾	70	1
EMi3 M 7,5-2 ⁽⁰⁾		7,5	905 x 460 x 705 ⁽²⁾	115	2
EMi3 M 10-2 ⁽⁰⁾		10		119	
EMi3 M 15-2 ⁽⁰⁾		15		209	
EMi3 M 20-2 ⁽⁰⁾		20		325	
EMi3 M 25-2		25		650 x 615 x 1320	
EMi3 M 30-2		30	850 x 615 x 1320	450	
EMi3 M 40-2		40	850 x 615 x 2120	527	5
EMi3 M 65-2		65		919	
EMi3 M 100-2		100		1227	
EMi3 M 150-2		150	850 x 1615 x 2120	1450	7-8
EMi3 M 200-2		200		2293	
EMi3 M 250-2		250		2820	

Tabla 5. Single phase models with input range $\pm 25\%$.

Model	Voltage	Power (kVA)	⁽¹⁾ Dimen. (mm) D. x W. x H.	Weight (kg)	Nr fig.
EMi3 T 15-4	three phase 3x380 V, 3x400 / 3x400 or 3x415 / 3x415 V with input voltage range $\pm 25\%$	15	905 x 460 x 705 ⁽²⁾	224	3
EMi3 T 15-4F				229	
EMi3 T 20-4				244	
EMi3 T 20-4F		20	905 x 460 x 705 ⁽²⁾	249	6
EMi3 T 35-4				495	
EMi3 T 35-4F		35	650 x 615 x 2120	500	6
EMi3 T 55-4				577	
EMi3 T 55-4F		55	850 x 615 x 2120	582	7-9
EMi3 T 70-4F				857	
EMi3 T 90-4F		90	850 x 1615 x 2120	1159	7-9
EMi3 T 110-4F		110		1227	
EMi3 T 140-4F		140	850 x 1615 x 2120	1298	7-9
EMi3 T 175-4F		175		1461	
EMi3 T 220-4F		220	3 single phase equipments 1650 x 815 x 2120	1870	10-11
EMi3 T 275-4F		275		2947	
EMi3 T 330-4F		330	3 single phase equipments 1650 x 815 x 2120	3762	10-11
EMi3 T 375-4F		375		3900	
EMi3 T 450-4F		450	3 single phase equipments 1650 x 815 x 2120	4169	10-11
EMi3 T 500-4F		500		4350	
EMi3 T 600-4F		600	3 single phase equipments 1650 x 815 x 2120	5610	10-11

Tabla 6. Three phase models with input range $\pm 25\%$.

Model	Voltage	Power (kVA)	⁽¹⁾ Dimen. (mm) D. x W. x H.	Weight (kg)	Nr fig.
EMi3 M 5-2 ⁽⁰⁾	Single phase 220 / 230V or 240 / 240 V with input voltage range $\pm 30\%$	5	590 x 340 x 585 ⁽²⁾	115	1
EMi3 M 7,5-2 ⁽⁰⁾		7,5	905 x 460 x 705 ⁽²⁾	119	2
EMi3 M 10-2 ⁽⁰⁾		10		196	
EMi3 M 15-2 ⁽⁰⁾		15		325	
EMi3 M 20-2		20	650 x 615 x 1320	390	4
EMi3 M 25-2		25	850 x 615 x 1320	450	
EMi3 M 30-2		30	850 x 615 x 2120	499	5
EMi3 M 40-2		40		650	
EMi3 M 65-2		65		956	
EMi3 M 100-2		100	850 x 1615 x 2120	1298	7-8
EMi3 M 150-2		150		1740	
EMi3 M 200-2		200		2820	

Tabla 7. Single phase models with input range $\pm 30\%$.

Model	Voltage	Power (kVA)	⁽¹⁾ Dimen. (mm) D. x W. x H.	Weight (kg)	Nr fig.
EMi3 T 15-4	Three phase 3x380 V, 3x400 / 3x415 / 3x415 V with input voltage range $\pm 30\%$	15	905 x 460 x 705 ⁽²⁾	231	3
EMi3 T 15-4F				236	
EMi3 T 20-4		20	650 x 615 x 2120	374	6
EMi3 T 20-4F				379	
EMi3 T 35-4		35	850 x 615 x 2120	533	7-9
EMi3 T 35-4F				538	
EMi3 T 55-4F		55	850 x 1615 x 2120	857	7-9
EMi3 T 70-4F		70		1159	
EMi3 T 90-4F		90		1227	
EMi3 T 110-4F		110		1298	
EMi3 T 140-4F		140		1477	
EMi3 T 175-4F		175		1870	
EMi3 T 220-4F		220	3 single phase equipments 1650 x 815 x 2120	2978	10-11
EMi3 T 275-4F		275		3860	
EMi3 T 330-4F		330		3900	
EMi3 T 375-4F		375		4350	
EMi3 T 450-4F		450		4698	
EMi3 T 500-4F		500		5610	
EMi3 T 600-4F		600		8460	

Tabla 8. Three phase models with input range $\pm 30\%$.

⁽⁰⁾ Models identified in tables 1, 3, 5 and 7 with this annotation ⁽⁰⁾, do not include the slot for SICRES (SL) and the RS232 connector (X33) as standard.

⁽¹⁾ The term «D. x W. x H.» corresponds to the maximum dimensions in mm of «Depth x Width x Height» and it includes those parts assembled as standard in each model that exceeds from the frame of the case or cabinet and they are essential for its operation or safety, like: switches, terminal cover, base (foot or stand), casters, ...

⁽²⁾ The lifting lugs are not contemplated in the total height of the equipment in the models corresponding to Fig. 1, 2 and 3. The lifting lug height is 45 mm, add it to the height stated in each model to get the total height.

The dimensions stated in tables 1 to 8 corresponds to standard equipments.

When an equipment includes the manual Bypass option, depending on the model (power and ranges), the physical dimensions can change as regards to the standard model, nevertheless and due to its easy connection, it will not mean any obstacle to do the needed tasks because the labelling in the equipment will identify those parts conveniently.

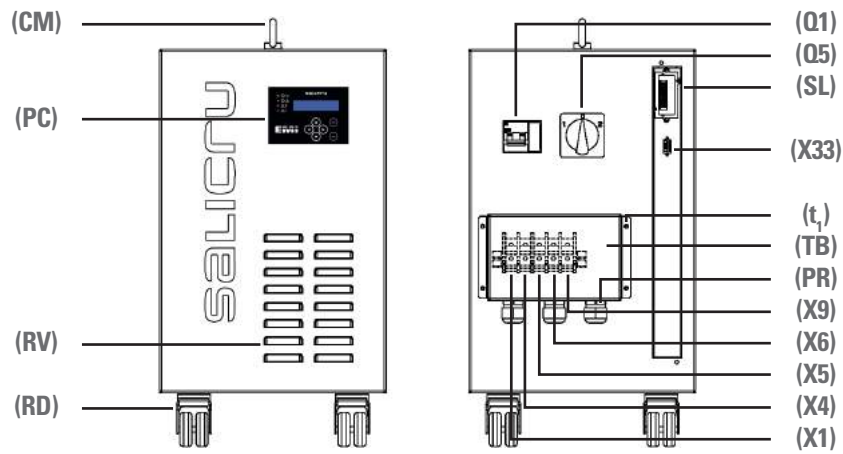

Fig. 1. Views of single phase equipment in case, format nr 1.

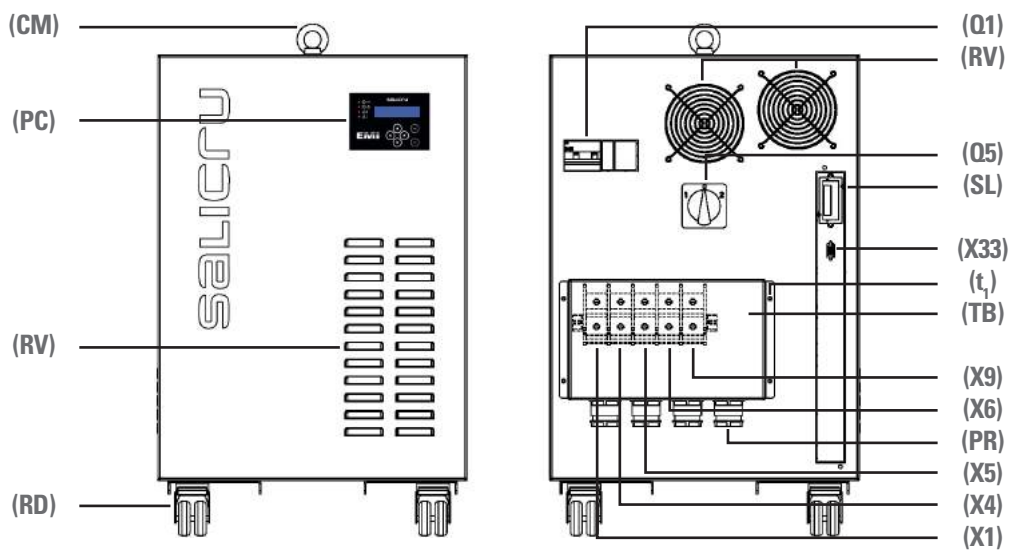

Fig. 2. Views of single phase equipment in case, format nr 2.

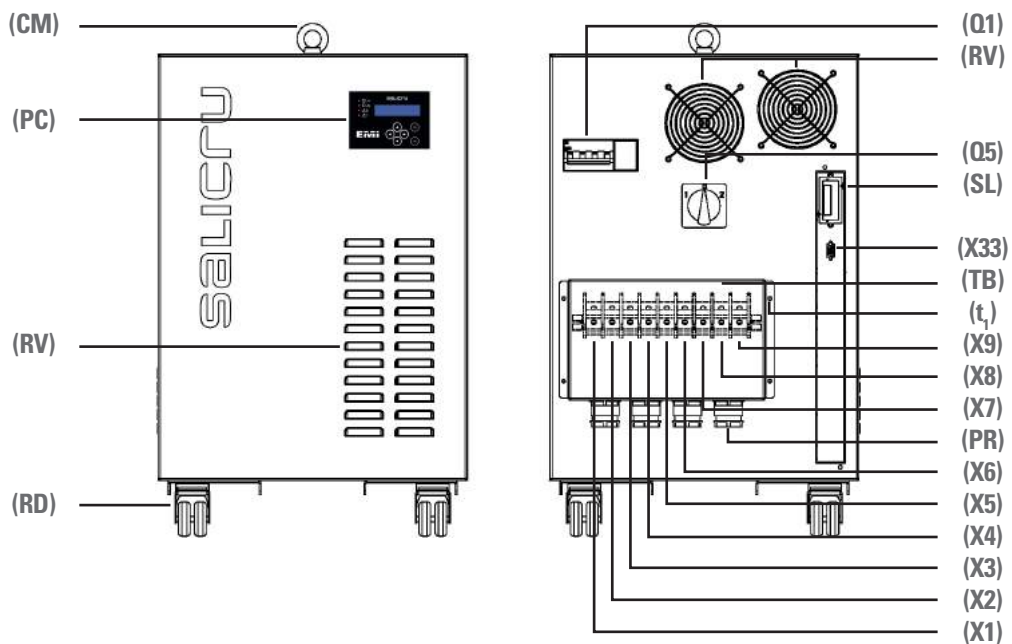

Fig. 3. Views of three phase equipment in case, format nr 2.

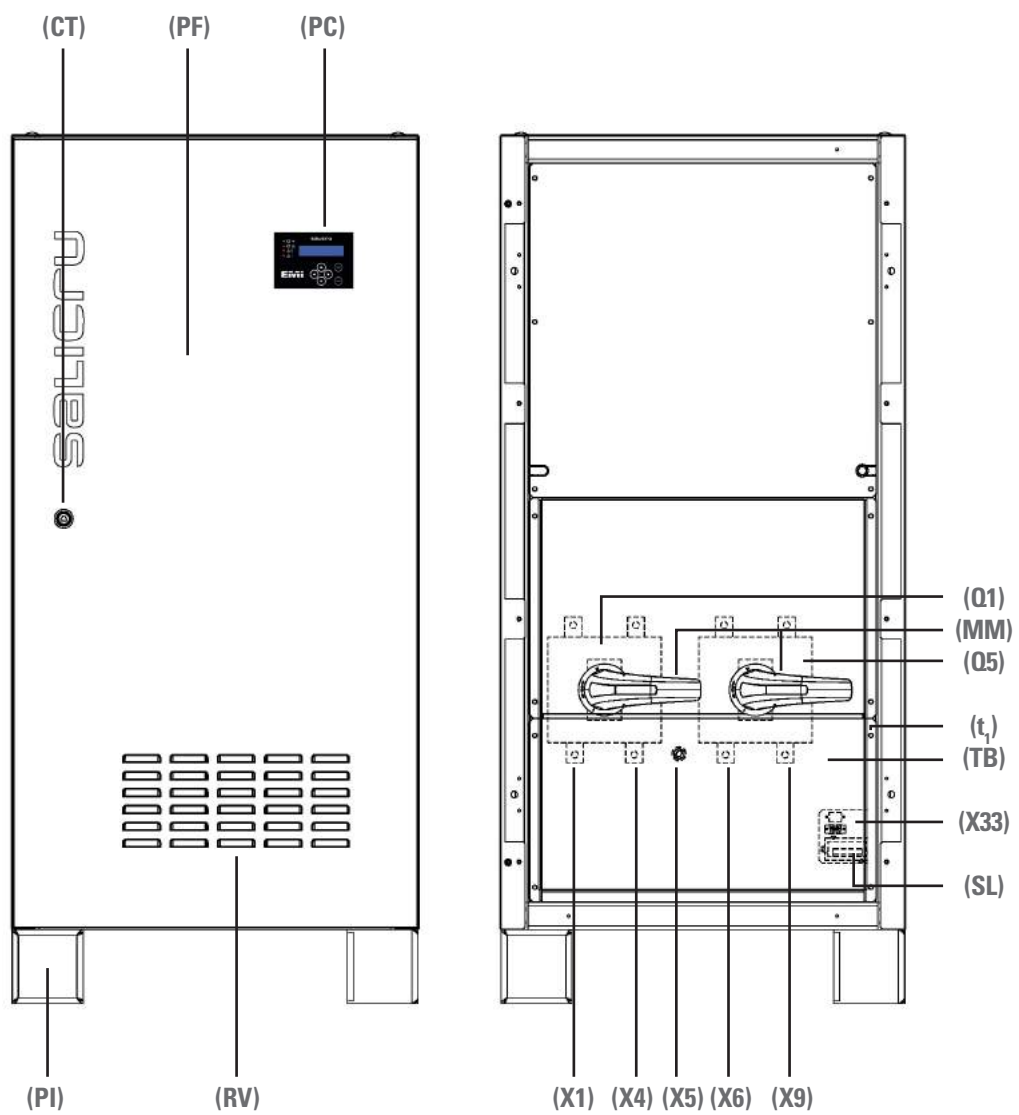

Fig. 4. Views of single phase equipment in cabinet, format nr 1.

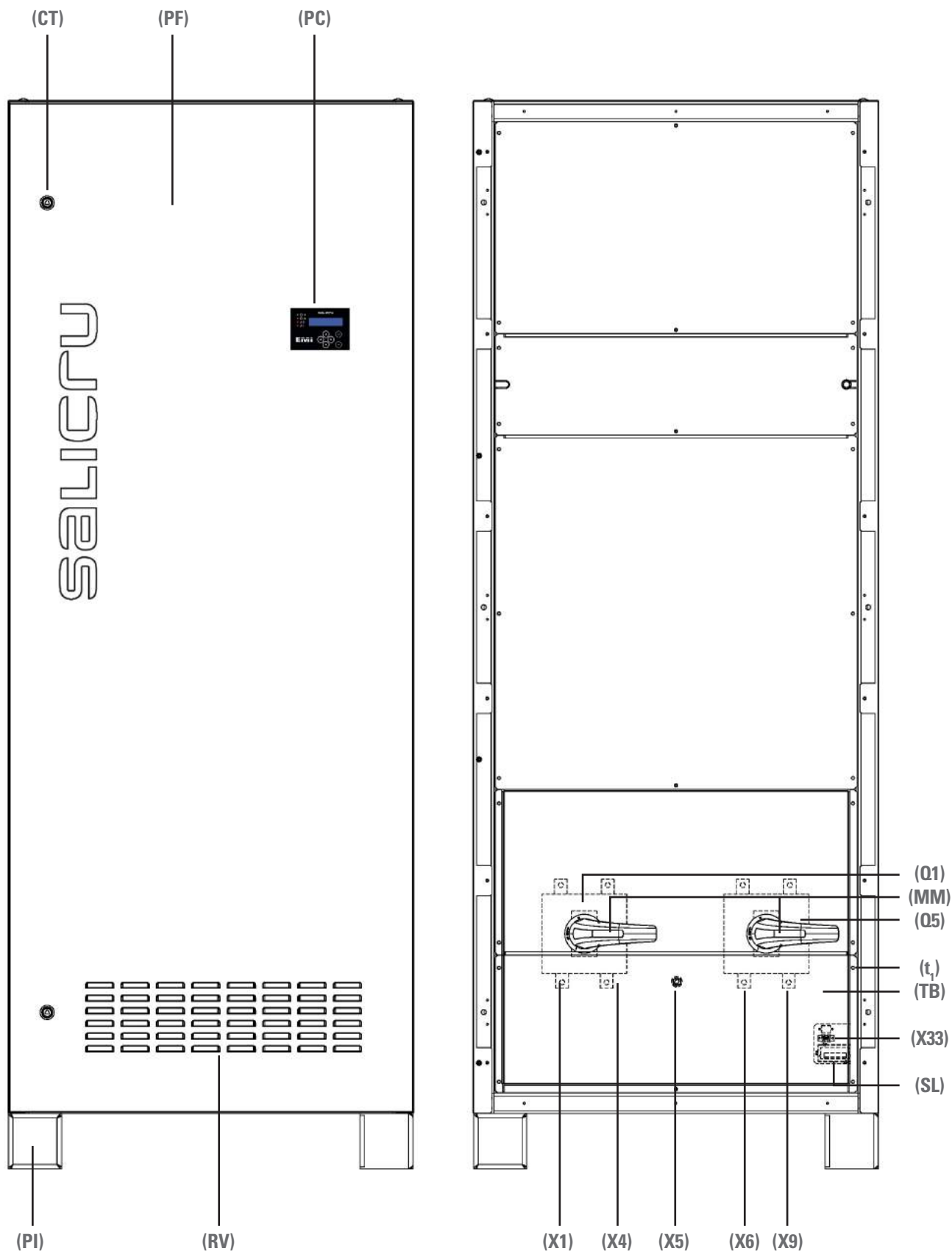

Fig. 5. Views of single phase equipment in cabinet, format nr 2.

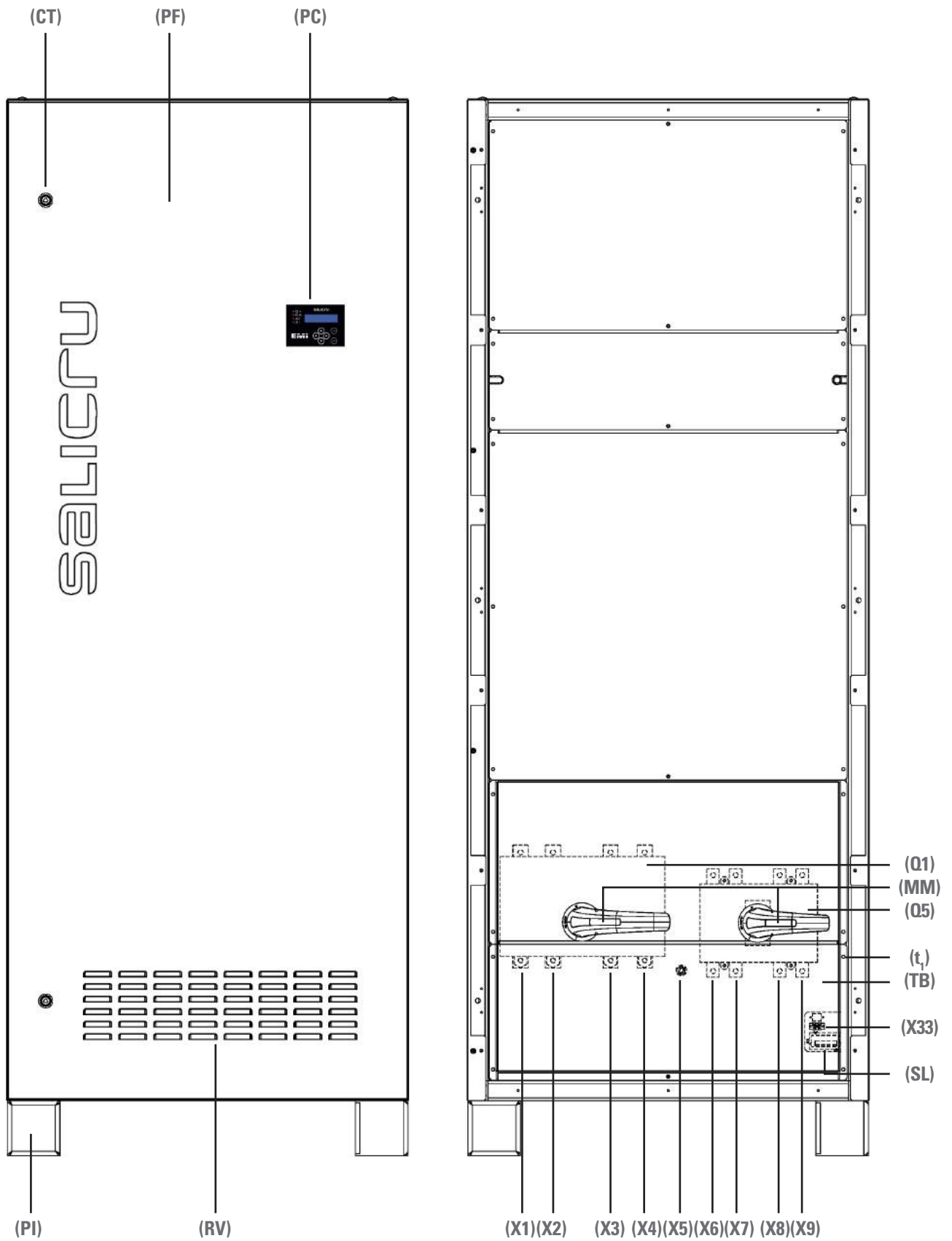

Fig. 6. Views of three phase equipment in cabinet, format nr 2.

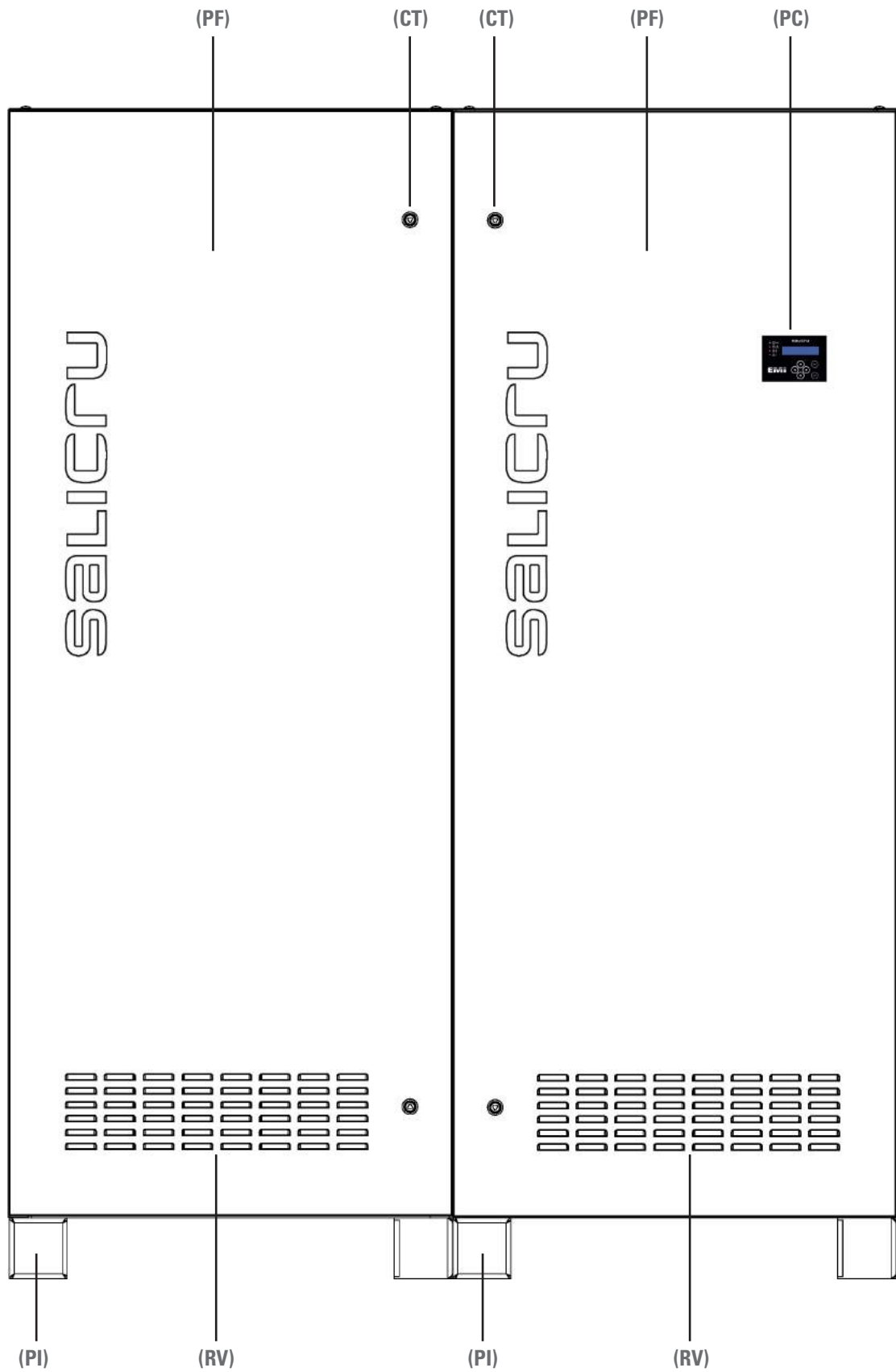

Fig. 7. Front views of both single and three phase equipments in cabinet, format nr 3.

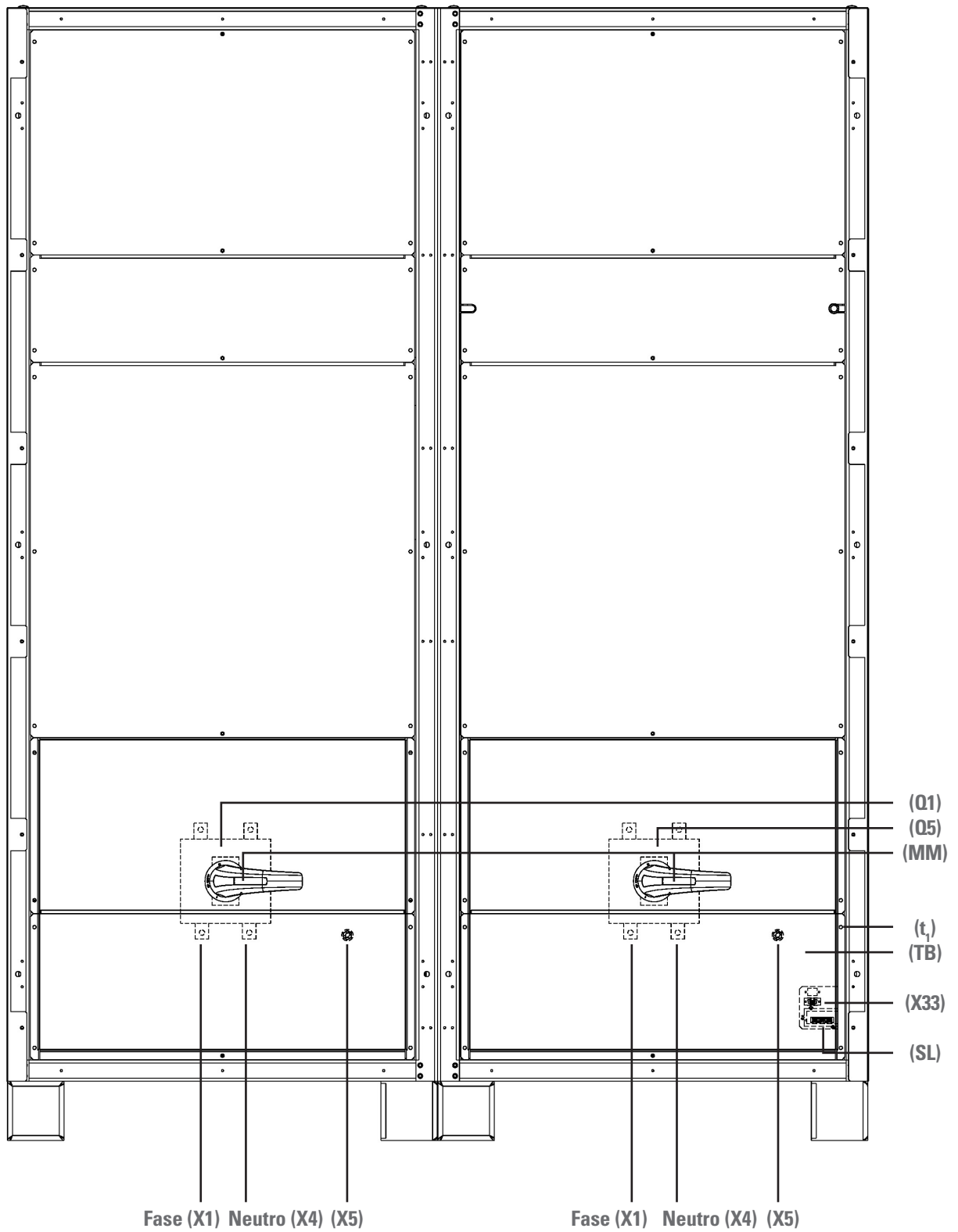

Fig. 8. Front views of single phase equipment in cabinet with door opened, format nr 3.

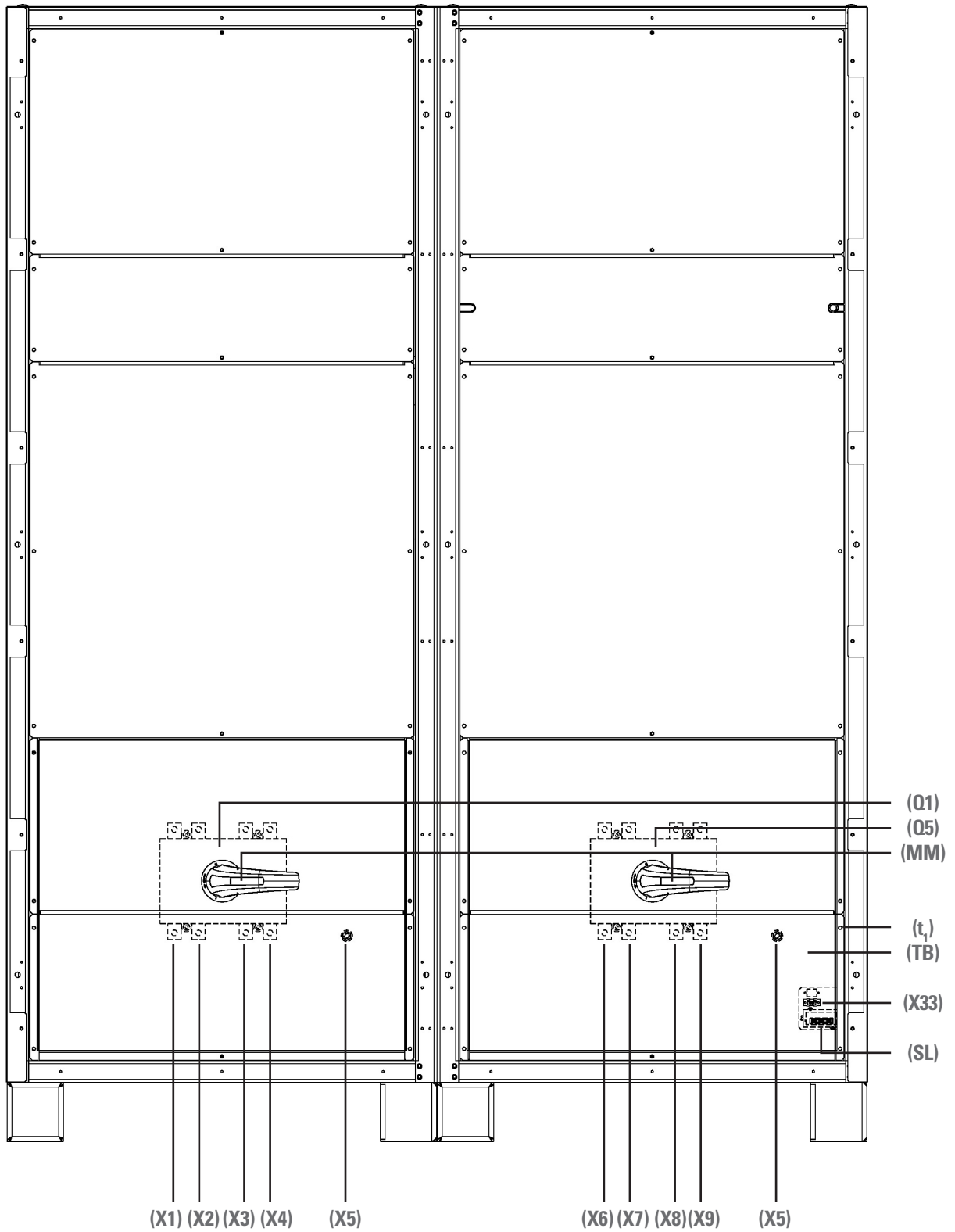

Fig. 9. Front views of three phase equipment in cabinet with door opened, format nr 3.

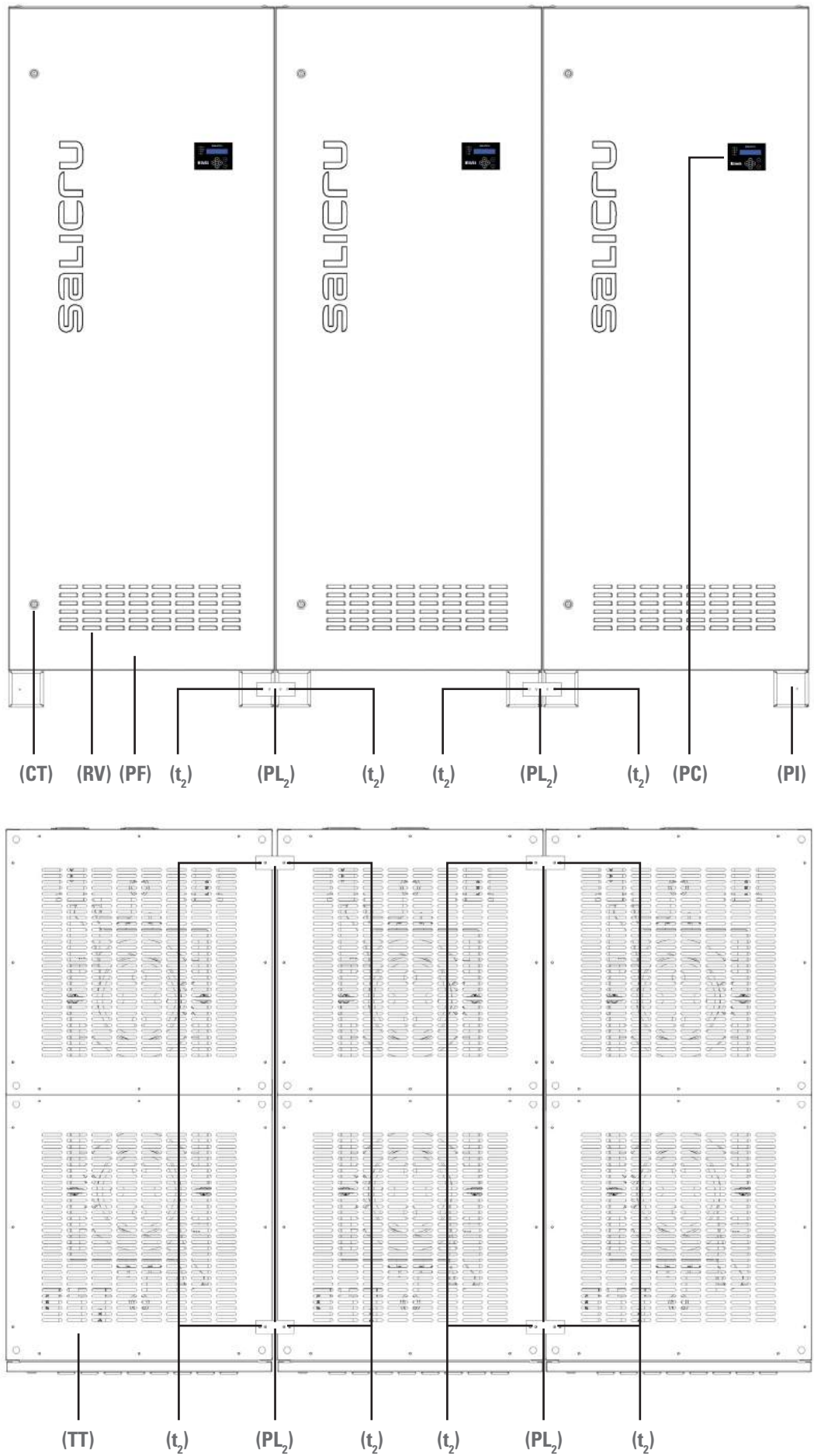

Fig. 10. Front and top view, three phase equipment consisting of three single phase units (to be joined once located).

Figures 10 and 11 are scaled as regards to the other views of the equipments and their dimensions can be checked in the respective tables 2, 4, 6 and 8 according to the model and voltage range.

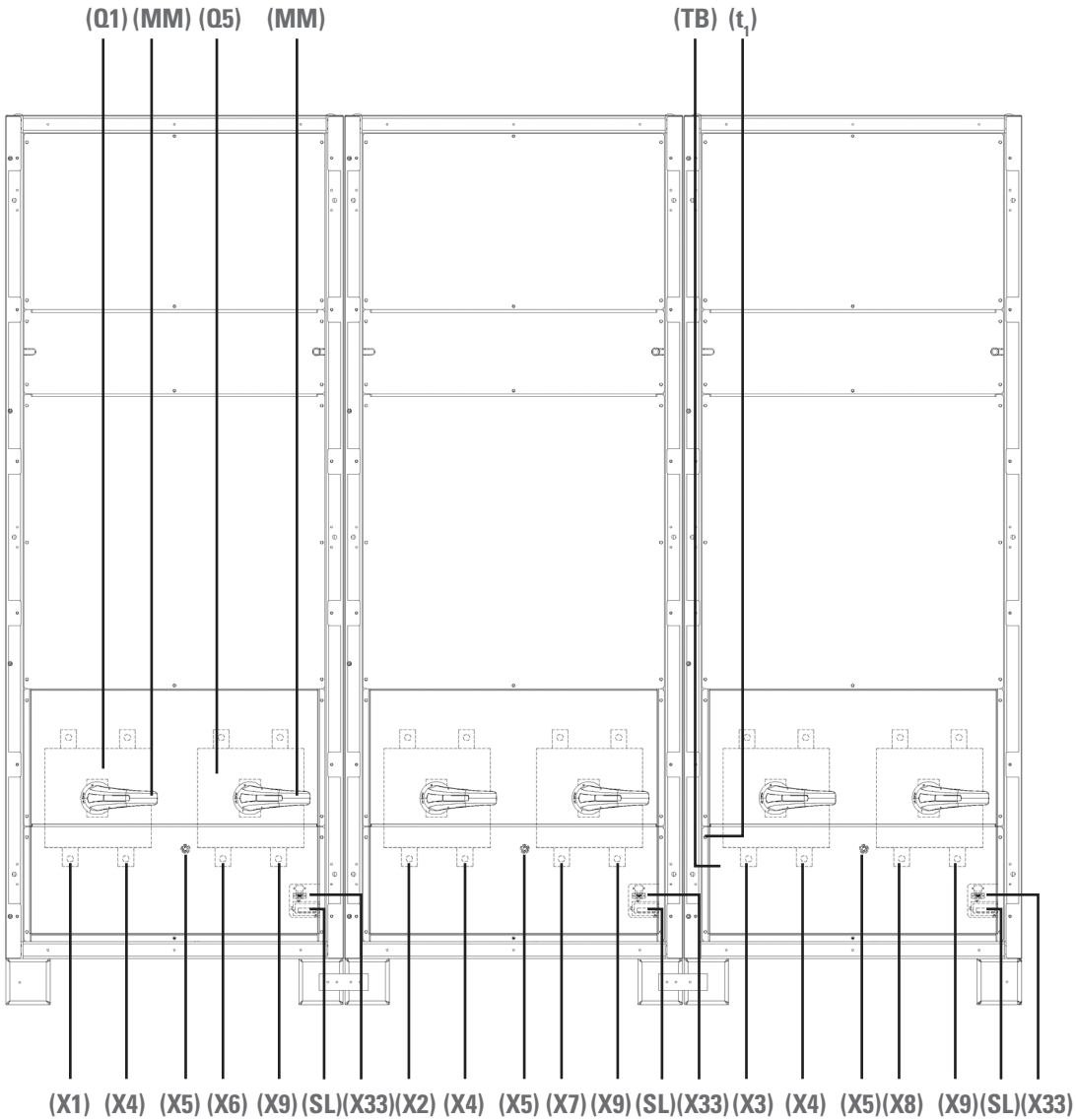



Fig. 11. Front view, three phase equipment consisting of three single phase units with door (PF) opened (to be joined once located).

4.1.2. Legends corresponding to the equipment views.





Connection parts:

- (X1) Input terminal phase R.
- (X2) Input terminal phase S.
- (X3) Input terminal phase T.
- (X4) Input terminal neutral N.
- (X5) Main protective earth terminal  and earth bonding terminal  for load or loads.
- (X6) Output terminal phase U.
- (X7) Output terminal phase V.
- (X8) Output terminal phase W.
- (X9) Output terminal neutral N.
- (X33) RS232 communication port. ⁽⁰⁾

Protection and manoeuvring parts:

- (Q1) Magnetic circuit breaker switches or breaker with input fuses.
- (O5) Manual bypass switch.

Control panel optical indicators and other ones:

- (a) Correct output voltage indicator. Green colour.
- (b) Alarm ON indicator. Red colour.
- (c) Urgent alarm indicator. Red colour.
- (d) Non-Urgent alarm indicator. Red colour.
- (e) LCD panel.
- (f) «ENT» key.
- (g) «ESC» key.
- (h) Upward key «».
- (i) Backward key «».
- (j) Right key «».
- (k) Left key «».

Other parts, abbreviations and auxiliary elements.

- (CM) Lifting lugs for equipments in case.
- (CT) Lock with ratched or cam with handle, for cabinet front door. It can include blocking system by means of key (LL).
- (LL) Key for blocking - unblocking the lock (CT).
- (MM) Breaker or switch manoeuvring handle.

- (PC) Control panel with LCD.
- (PF) Cabinet front door.
- (PI) Leveller feet, cabinet base plinth.
- (PL₂) Rod to joint the equipment through the top and the base plinth of the cabinets.
- (PR) Cable gland or bushing cones for cable entry. In equipments of high power there is a slot for the cable entry connection.
- (PT) Extension rod for equipment consisting of three single phase cabinets, to joint the neutral rod (option).
- (RD) Swivel casters with brake in models in case.
- (RG) Terminal strip for IR option (dry contacts to terminals in control panel with LCD).
- (RV) Cooling grids. Natural cooling and in some models it is forced.
- (SL) Slot for SICRES Ethernet communication card (the own SICRES card is optional). ⁽⁰⁾
- (TB) Terminal protection cover.
- (TT) Cabinet top covers.
- (t₁) Screws for fixing the terminal cover (TB).
- (t₂) Self-tapping screw with TORX head for fixing the rod (PL₂) that joint the cabinets.

⁽⁰⁾ Models identified in tables 1, 3, 5 and 7 with this annotation ⁽⁰⁾, do not include the slot for SICRES (SL) and the RS232 connector (X33) as standard.

4.2. DEFINITION OF THE PRODUCT.

4.2.1. Nomenclature.

EMi3 T 20-2TFMR-BM IR WCO ±20% 3x220V T/T ±4% EE595328

EMi3	Particular client specifications.
T	Output accuracy, if its different from ±1 %.
20	Input/ouput configuration, star/star.
2	Input/ouput configuration, star/delta.
2/4	Input/ouput configuration,delta/delta.
M	Input/ouput configuration,delta/star.
T	Nominal voltage of equipment. Omit for 3x400 V or 230 V.
M	Input range, if it is different from ±15 %.
20	"Made in Spain" marking in the equipment and pack-aging (custom issue).
M	Neutral brand equipment.
T	Dry contacts of LCD control panel to terminals.
2	COM card.
2/4	Manual bypass.
M	Max-min output voltage protection with automatic rearming.
T	Max-min output voltage protection with manual re-arming.
2	Max-min output voltage protection with automatic rearming and overload protection.
2/4	Independent phase regulation.
M	Isolation transformer, usually fitted in the output. It can also be fitted in the input as voltage adaptor or for changing the voltage configuration, i.e. E/T (star/delta).
T	First character of the common voltage.
2	First character of the input/output voltage.
2/4	Power in kVA.
M	Single phase equipment.
T	Three phase equipment.
EMi3	Servomotor stabilizer family series.

4.3. PRESENTATION.

EMi3 stabilizer model has been designed to operate in fluctuated mains and to safeguard the critical loads, in particular, those ones with a complicated nature: high inrush start up currents, high reactive character, high powers, etc. These equipments are very robust against long overloads and they have a high output accuracy (up to $\pm 1\%$), they are manufactured in single and three phase structures with independent phase regulation or average regulation in the three phases depending on the model.

Any three phase servomotor stabiliser has only one electronic control card for all the phases and one LCD panel for its monitoring and complete control, less those ones that consist of three independent single phase equipments duly connected to make a three phase equipment. In these ones, each cabinet will have its own electronic control card and its LCD panel.

Depending on the total power of the three phase equipments, no matter if they include some options or not, they are supplied assembled in one metallic cabinet, divided in two cabinets joined together mechanically at factory or by three separate cabinets, which will be joined after their final location.

The input and output are marked in the terminal strips of the equipment. When installing the device, use the suitable cross cable section in order to guarantee its correct operating.

The LCD of the control panel of the stabilizer allows checking the input/output voltages and frequency, whenever you need. Also, the LCD has measurements of output current, active and apparent powers per phase and total, power factor per phase and total and load percentage per phase. These last measurements are only available when the equipment includes the current transformers in each one of the output phases (option). There are LED indicators to inform about both the status of the equipment and the possible active alarms.

Single line diagram of a single phase equipment is shown in Fig. 12 (the three phase structure is similar to it but repeating the same block per each phase).

4.4. DESCRIPTION OF THE EQUIPMENT.

The EMi3 voltage stabilizer series is a stabilizer, which due to its simplicity, reliability and robustness, has achieved to persist along the time, but with a re-designing, which has given technical improvements in electrical, electronic and mechanical.

The equipment can be used to stabilize the power supply of any kind of machine, which doesn't require a regulation with a high response time, but it requires a constant and accurate stabilization, in particular those ones tending to be complicated: high start up inrush currents, high reactive power, high powers,... etc.

The equipment makes a sensitive and efficient stabilization of the output voltage through its incorporated Booster transformer, Variac and microprocessor.

To keep the output stable with a minimum tolerance, the servo-system uses a control of the DC motor by means of MOSFET transistors.

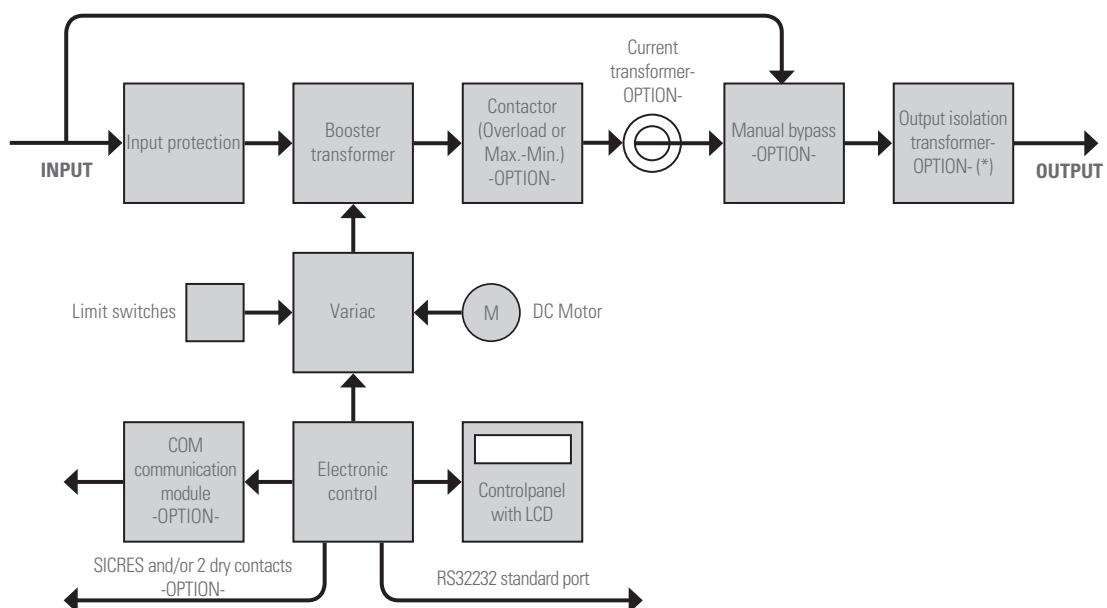

Fig. 12. Single line diagram.

The LCD panel shows the values of the input/output voltages and frequency. The measurement of output current, active and apparent powers, power factor are available with the output current transformers option. Also, the LED indicators inform about the status of the equipment. To know in detail the LCD panel information and the meaning of the LEDs go to the corresponding section of this manual (section 7). The input fuses or circuit breaker protections, provides protection against long over currents to both the loads and the stabilizer. Depending on the model and the protection degree IP, the cooling is natural or forced, in order to keep the internal temperature stable.

Although the input voltage range is $\pm 15\%$ for the standard models, under request, it is possible to manufacture equipments with wide input voltage range up to $\pm 30\%$ (input voltage window).

The voltage stabilizer protects against sudden changes, irregularities, increasing or decreasing of the voltage mains by means of an accurate voltage stabilization.

Also, as standard the control electronic unit includes the Maximum and minimum voltage protection signal (adjustable to input or output, but by default on the last), which is needed to disconnect the output by means of a contactor, which can be fitted in as an option at the factory, in case of the voltage exceeds the allowed limits or mains fault. In order to keep the protection against sudden voltage changes, the signal is delayed a few seconds.

It is also possible to include an option that allows disconnecting the output of the stabilizer due to overload. In this case, the equipment will include the output current sensors to make the overload measurement.

As an option, the stabilizer can be equipped with a manual Bypass, which is not ready to be manoeuvred with load connected. It allows keeping the loads supplied during the maintenances or fixing periods.

Regarding the communications, to highlight that the equipment is supplied with a RS232 serial communication port and a Slot to insert the SICRES Ethernet card. Under request the communications of the stabilizer can be upgraded by 2 programming dry contacts connected to terminal strip or even by implementing the communication module, which includes two serial communication channels and 9 additional dry contacts.

4.5. MAIN QUALITY PERFORMANCES.

- Wide range of powers for single and three phase installations.
- Toroidal autotransformers (Variacs) for all the power range, fast and efficient with DC motors of 12 V or 24 V.
- Output accuracy, better than 1 % (adjustable).
- Depending on the three phase equipments model common and independent regulation per phase, they are immune to unbalanced loads.

- As standard, input voltage range of $\pm 15\%$, being able to manufacture ranges up to $\pm 30\%$.
- High efficiency, up to 97,5 %.
- High response time, up to 70 V/sec.
- Complete control panel with LCD to supervise the stabilizer.
- Output accuracy guaranteed by a control with MOSFET servo.
- Immune to line voltage harmonics; True RMS stabilization.
- Stable operating against load and/or voltage fluctuations.
- Wide operating temperature ranges ($-10\text{ }^{\circ}\text{C}.. +55\text{ }^{\circ}\text{C}$).
- Dry contacts (2 as standard up to 11 as an option).
- Nil voltage harmonic re-injection.
- Optimized mechanical design, easy maintenance.
- Overload up to 200 % over the nominal for 20 sec..
- High robustness and reliability (high MTBF).
- Silent operating.
- Recyclable material in more than 80 %.

4.6. OPERATING PRINCIPLE

The electronic control manages the output voltage of the stabilizer permanently, providing a correction signal the DC motor, in order to achieve the wanted output voltage with an accuracy of $\pm 1\%$ (adjustable from $\pm 0,5\%$ up to $\pm 5\%$). The motor acts over the toroidal autotransformer, by increasing or decreasing the voltage, by moving the brush in the variable tap in one way or to the other.

The resultant voltage is applied to the primary winding of the «Booster», which adds in phase or counter phase the voltage to the mains through its secondary winding, by stabilizing in this way any fluctuation over the nominal voltage that could occurs.

If the input voltage is higher than the voltage range of the equipment, the output regulation will reach its maximum or minimum correction and from this point the voltage difference will be added or subtracted to the output directly, unless the equipment has the Maximum-minimum output voltage protection (see section 4.7.2), which will avoid supplying the loads out of the output voltage range, so it will break the power supply to the loads when the ranges is exceeded.

I.e., an equipment with $3x400\text{ V} \pm 15\%$ ($3x340.. 460\text{ V}$) and without Maximum-minimum protections, when the input voltage is $3x330\text{ V}$ the output voltage supplied to the loads will be $3x390\text{ V}$. The difference between the low voltage regulation ($3x340\text{ V}$) and the applied voltage at the input terminals ($3x330\text{ V}$) is 10 V . This voltage difference, that the stabilizer cannot correct will be subtracted from the nominal output voltage ($3x400\text{ V}$), because the output voltage cannot be stabilized beyond of the design range, so the loads will be supplied at $3x390\text{ V}$.

As an option, if the application would need it, the range could be extended from the standard $\pm 15\%$ to a wide one (i.e. $\pm 25\%$), by requesting an equipment with extended voltage range.

4.7. OPTIONS

4.7.1. Measurement of output currents, powers and overload.

As standard the EMI3 stabilizer does not include the output current measurements, although they can include the sensors as an option. This option incorporates to the equipment one or three current transformers at the output, depending if it is a single or three phase equipment. Therefore, the LCD panel will display some data derived from these current measurements like:

- Depending on the equipment, single or three phase, one or three output currents.
- Depending on the equipment, single or three phase, one or three active output powers.
- Depending on the equipment, single or three phase, one or three apparent output powers.
- Depending on the equipment, single or three phase, one or three output load percentage.
- Depending on the equipment, single or three phase, one or three output power factors.

Thanks of having the current transformers, some alarms would be activated too: over current or overload in case of exceeding the nominal currents or powers of the stabilizer.

4.7.2. Maximum-minimum output voltage protection.

The Maximum-minimum protection is an option that includes a contactor to break the input or output voltage of the equipment in case the voltage is out of the preset range. By default, it is set to $\pm 7\%$.

This option can be set with different operating ways:

1. Maximum-minimum input or output voltage (by default at the output).
2. Protection of only Maximum, only Minimum or Maximum-Minimum voltages (by default Maximum-Minimum).
3. Manual or Automatic rearming of the Maximum-minimum protection (by default Automatic mode).

The Maximum-minimum protection window is defined by the range, which are the particular ones for this operating.

4.7.2.1. Manual/Automatic operating.

- Manual.
When the equipment exceeds the preset range, depending on the maximum-minimum contactor configuration, it will break the output or input voltage. Whereas the voltage is restored inside the preset range, the stabilizer will not supply output voltage, because the contactor must be rearmed manually by selecting "YES" in the screen 2.2 from "manoeuvring" submenu (see Fig 19 and/or 20).

- Automatic.

The system will supply output voltage meanwhile the voltage is inside the preset range, otherwise the output will be broken. The stabilizer will shift from one condition to the other one in an automatic way, without any manual intervention but with a rearming time delay of 5 sec., by default, however it can be adjusted to other values at factory.

4.7.3. Bypass Manual.

Manual bypass option consists in a three positions cam switch, which allows selecting between position «1», where the output is connected to the input of the stabilizer directly (Bypass) and position «2» where the output of equipment is connected to the output of the stabilizer directly. The shifting from one position to the other one will always be done with a break, shifting through the position «0», so it means that the power supply to the output will not be guaranteed during the switching.

4.7.4. Overload contactor.

This option incorporates the overload contactor and the parts included in the option of «Measurement of output currents, powers and overloads» described in section 4.7.1.

The operating of the system is always with manual rearming, so if the stabilizer senses a current from 100% and 200% of the nominal, an over current alarm will be triggered and a timer of 20 sec. will be started. Once the time is elapsed the overload contactor will be opened, breaking the power supply at the output. Then the screen of the LCD panel will display the overload alarm. The rearming will be done manually through the screen «General Rearming» in the manoeuvring menu, although the end-user will have to disconnect loads from the output of the stabilizer to guarantee the re-start up. The equipment will start up normally.

4.7.5. Non-critical loads contactor.

This option incorporates the Non-critical load contactor and the parts included in the option of «Measurement of output currents, powers and overload» described in section 4.7.1.

Another of the features of this option is that the stabilizer will have a double output terminal strip:

- Critical Loads output terminals.
- Non-critical Loads output terminals.

The operating of the system is always with manual rearming, so if the stabilizer senses that the 50% of the nominal load has been reached, the «Non-Critical Loads Disconnection» alarm will be triggered and a timer of 20 sec. will be started. Once the time is elapsed, the «Non-Critical Loads Disconnection» contactor will be opened, breaking the output power supply to these loads. The rearming will be done through the screen «General Rearming» of the manoeuvring menu, although the end-user will have to disconnect loads from the output of the stabilizer to guarantee the re-start up. The equipment will start up normally.

4.7.6. Communication and dry contacts module.

The communication module has several communication ways with the external environment. In general, it can be said, that beside of the Slot to insert the SICRES Ethernet communication card, there are several communication ports and 9 dry contacts (see user's manual EN030*00).

4.7.7. Budget version of the dry contacts to terminals.

In case the end-user doesn't need so many dry contacts, as an option there is the possibility to have two dry contacts with the following setting:

- Internal dry contact 1. Output overload or Maximum-minimum protection.
- Internal dry contact 2. General alarm.

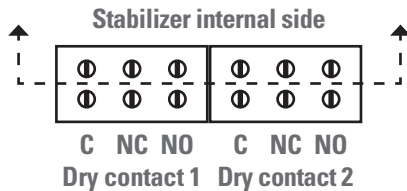

Fig. 13. Dry contact interface layout.

The switched dry contacts are supplied connected to a terminal strip as the layout of Fig. 13 shows.

The maximum applicable voltage and current is 250 V AC 6A.

4.7.8. Slot for SICRES Ethernet communication card.

Any stabilizer is supplied with the Slot to fit the SICRES communication option. This card can be fitted in from factory or later on.

All the information regarding this option is described in the user's manual EK764*00 supplied with the CD-ROM together with the own SICRES card.

In three phase stabilizers of high power rate consisting of three single phase equipments, each single phase unit has its own Slot for the SICRES communication card.

4.7.9. Galvanic isolation transformer.

The isolation transformer is built with separate windings and it has an electrostatic shield between the primary and secondary windings, which provides a high level of electrical noise attenuation (> 40 dB).

This option can be built in either inside the EMI3 series attending to different operating conditioning or in a separate case.

Among other functions a part from the isolation, it can act as:

- Input or output voltage adaptor.

- Configuration adaptor: delta-star or vice versa...).
- And even combining the two above options depending on the case.

As a result of the possible combinations, this document does not consider the power standardization of tables 1 to 8 in the assembling with isolation transformer, because the physical dimensions and weight will vary, but in any case its main feature of galvanic isolation will not be affected.

4.7.10. Other regulation ranges.

The voltage regulation ranges of the equipment are $\pm 15\%$. Under request, the stabilizers can be supplied with different ranges and up to $\pm 30\%$, and even without being symmetrical.

4.7.11. External manual Bypass panel.

The purpose of this option is to isolate the equipment and the loads electrically. Therefore, the maintenance or fixing tasks in the equipment can be done without any break in the power supply of the protected system, also unnecessary risks to the technical staff are avoided.

The basic difference between this option and the internal manual bypass in the own stabilizer is the higher operating, because it allows disconnecting the equipment from the own installation completely.

In Fig. 14 is shown a Panel with input and output switches, being able to have them or not according to the requested order.

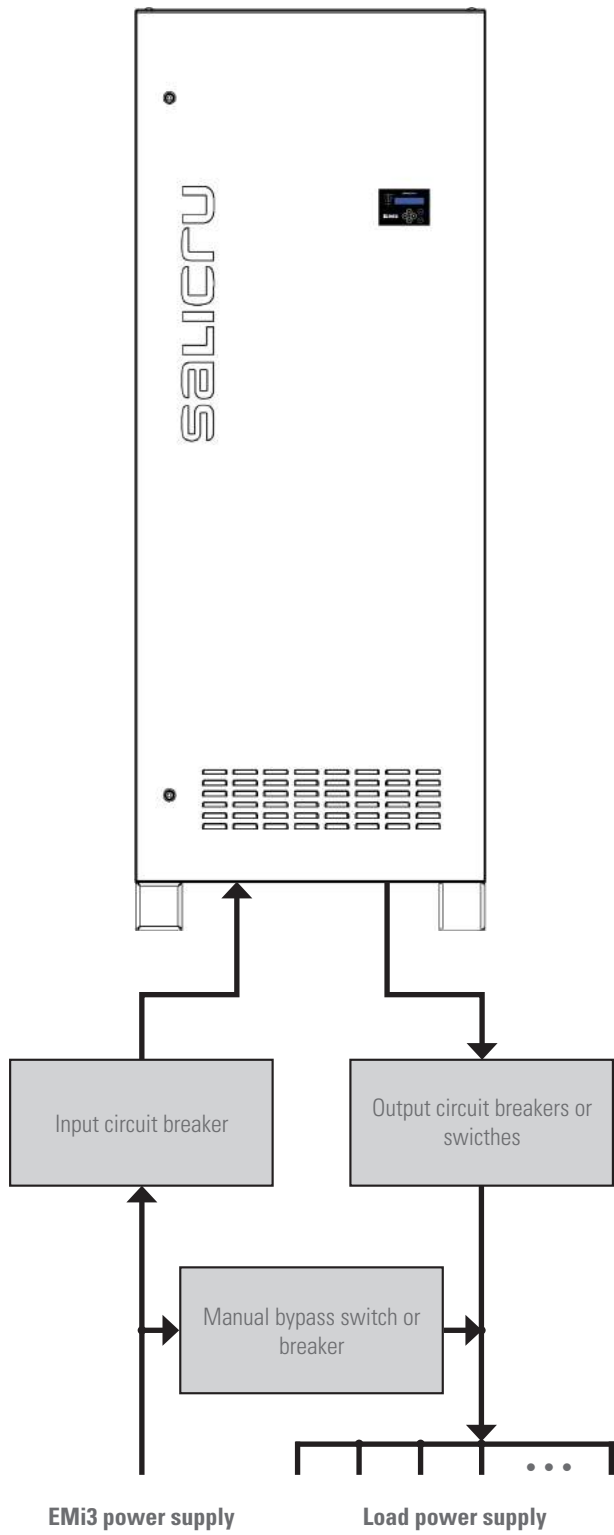







Fig. 14. Manual bypass panel single line diagram including input and output switches.

5. INSTALLATION.

-  Read and respect the Safety Information, described in section 2 of this document. To obviate some of the indications described in it, can cause serious or very serious injuries to the persons in direct contact or in the vicinity, as well as faults in the equipment and/or loads connected to itself.
- Check that data in the nameplate are the required ones by the installation.
- A wrong connection or manoeuvring, can cause faults in the stabilizer and/or loads connected to it. Read the instructions of this manual carefully and follow the stated steps in the established order.
-  The equipment must be installed by qualified personnel and it can be used by personnel with not specific training, just with only help of this «User's manual».
-  Any connection of the equipment, including the control (interface, remote control, ...), will be done with all the switches in rest and no mains present (power supply switch of the equipment turned «Off»).

5.1. TO CONSIDER IN THE INSTALLATION.

- The equipments have terminals for its input and output connections. Nevertheless some models due to their high power rate, the power supply cable connection is directly done in the own terminals of the input switch or breaker, when they have rods.
- As regards to the protective earth connection and earth bonding connection, the equipments have an earth terminal or stud, less those double cabinets, which will have two earth connection points by means of studs, one for the main protective earth cable and the other one for the earth bonding for the load or loads.
- For the equipment communication, it is supplied a RS232 port with DB9 connector and the Slot for the SICRES Ethernet card.
As an option, it is available other communications ways:
 - 2 dry contacts of alarm from the LCD panel connected to a terminal strip.
 - Communication module, which includes up to 2 serial ports, 9 programming dry contacts, 1 analogical input and another one digital. For more information see document EN030*00.
- The nameplate of the equipment contents the maximum input current (corresponding to the nominal power with low voltage regulation) and the nominal output. The efficiency of the equipment has been considered to calculate the input current.
Overload condition is considered as a nonpermanent and exceptional way.

- In case peripheral elements are added at the input or output like transformers or autotransformers, The current of the nameplates of these elements has to be considered in order to select the suitable cross cable section, by respecting the Local and/or National Low Voltage Electrotechnical Regulations.
- Regarding the size of the terminals of the built switches in the protection panel, the cross cable section has to be considered, in order to leave them completely embraced in all its section, in order to have an optimal contact between both elements.
- It is compulsory that the line that supplies the stabilizer includes the input protection, which allows to break it to make the connection tasks with no voltage, otherwise it could mean a danger of the fitters.
It is recommended to equip the installation with a switch-gear protection panel, which besides of the input protection, it has an output protection and manual Bypass switch. Under request, it can be supplied or you can opt for manufacturing it by yourself by following the information stated in the documentation CD-ROM.
The start up and shutdown operating instructions are described in the user's manual, considering that the installation is provided with a complete panel like the recommended one. If it is not available omit the protection or switch manoeuvring.
-  The documentation supplied together with this user's manual and/or in the CD-ROM, and the information regarding the «Recommended installation» can be checked. This information shows the wiring diagram, protection sizes and minimum connecting cross cable sections, attending to the nominal operating voltage of the equipment. All the values are calculates for a maximum cable length of **30 m** between the protection panel, equipment and loads.
 - For higher lengths correct the cross sections in order to avoid dropping voltages, in accordance with the particular Regulations or norms of the country.
-  The size and type of the protection to install will be the stated in the information related to «Recommended installation», supplied together with this user's manual in the documentation CD-ROM.
- The neutral regimes of the input and output are identical for the EMI3 stabilizers «with no galvanic isolation».
-  When, as an option, an equipment incorporates a galvanic isolation transformer, which can be built in from factory or by your own, either at the input or output of the equipment, protections for indirect contact must be fitted in (RCD) at the output of each transformer, because in case of electrical shock in the secondary winding, due to its isolation feature, it will impede the tripping of the protections located in the primary of the transformer (isolation transformer output).
- We remind you that any isolation transformer fitted in or supplied from factory, has the output neutral earthed through a cable that joints the neutral an PE terminals. If an isolated output neutral were needed, this cable bridge

must be removed, by taking the needed cautions as regards to the local and/or national regulations.

- Switches, breakers and protections must break the NEUTRAL a part from the lines, in case of installation in IT neutral regime.

5.2. EQUIPMENT RECEPTION.

5.2.1. Unpacking, inspection and contents checking.

- To unpack it, see section 5.2.3.
- When receiving the equipment, check that no incident has happened during transport (impact, fall, ...) and the specifications of the equipment correspond with the ones stated in the order, therefore it is recommended to unpack the stabilizer in order to make a first visual inspection.
- In case of incidents, make the needed claims to your supplier or in lack of him to our firm.



Never start up an equipment when external damages are detected.

- Also check data in the nameplate stucked in the packaging and equipment, correspond to the ones stated in the purchase order, so it will be needed to unpack it (see section 5.2.3). Otherwise, make the nonconformity as soon as possible, by quoting the serial number of the equipment and the references of the delivery note.
- Check the packaging contents:
 - The own equipment.
 - User's manual in digital format (CD-ROM).
- Once the reception is finished, it is advisable to pack the equipment again till its commissioning in order to protect it against mechanical impacts, dust, dirt, etc.

5.2.2. Storage.

- The storage of the equipment, will be done in a dry and cool place, and protected from rain, dust, water jets or chemical agents. It is advisable to keep the equipment inside its original packaging because it has been designed to assure the maximum protection during transport and storage.
- Respect the storage specifications of the equipment stated in section 9.

5.2.3. Unpacking.

- The packaging of the equipment has wooden pallet, cardboard or wooden enclosure depending on the case, polystyrene corners (EPS) or polyethylene foam (EPE), plastic wrap and polyethylene strip, all of them are recyclable materials; so if you are going to dispose them, do it in accordance with the regulations in force. It is recommended to keep the packaging, in case it would have to be used in future.

Nevertheless, models in cabinet (see Fig. 4 to 11) are supplied with no pallet, unless the transport is by sea or it was requested in the order.

To move it, use a pallet jack or forklift through the own base of the cabinet.

- Proceed to unpack the equipment. To do that, cut the strips of the cardboard and take it out from top like a cover or dismantle it with the needed tools if it is a wooden enclosure; remove the corners and plastic wrap.

Models in Fig. 1, 2 and 3 are bared over a honeycomb cardboard base, which is used as shock absorber and at the same time it is over the wooden pallet. These units have two lifting lugs to make easier the lifting tasks of the equipment and the pallet removing.

5.2.4. Transport till its location.

- Equipments in case have four casters, in order to make easier their transport until their location.

Nevertheless, if the reception area is far from the installation place, it is recommended to move the equipment by means of pallet jack or the suitable means evaluating the remoteness between both points.

If the distance is long, it is recommended to move the equipment packed till the installation area and later on unpack it.

- For models in cabinet, it is essential to move it with mechanical means till the final location.

5.2.5. Location.

- Place the equipment attending the indications and recommendations in the safety instructions EK266*08.
- Equipments with casters, block the brake in all of them.

- Models consisting of three single phase equipments, put them together according to Fig 10. The physical layout of each one of them is conditioned by the equipment with no side covers, which will be located in the middle position. The other two, will be located at both sides, in such way that all the set will be closed in all its sides.

With the purpose of joint them, 8 rods (**PL₂**) with four wholes in each, are supplied. To fix them, some self-tapping screws with TORX head (**t₂**) that fix the top cover and (**t₂**) in the base plinth (**PI**) will be used.

Proceed as follows to joint the cabinets, once they are placed and aligned (see Fig. 10 and 11):

- Remove the screws (**t₂**), which are supplied fitted in the base plinth (**PI**), both front and rear sides of the cabinet.
- Joint the central cabinet with the two adjoining ones by using the four rods (**PL₂**) and fix it by means of the screws (**t₂**) previously removed. Repeat the same action in the front and rear sides.
- Remove the screws (**t₂**) stated in Fig. 10, which are used as fixing elements for the top cover.
- With the remaining four rods (**PL₂**), fix the central cabinet with the two adjoining ones through the wholes in the top and by means of the screws (**t₂**), which have been removed previously.

-  In case were needed to change the location of the equipments, these joint rods have to be removed previously.

5.3. CONNECTION.

-  This equipment is ready to be installed in mains with power distribution system TT, TN-S, TN-C or IT, keeping in mind during the installation the features of the used system and the national electrical system of the final country.

-  The cross cable sections used to supply the equipment and loads, will be in accordance with the power stated in the nameplate stucked in the equipment, respecting the Low Voltage Electrotechnical Regulation or norms of the corresponding country.

- The installation will be provided with input protections, RCD and circuit breakers sized to the current stated in the nameplate of the equipment at least, and characteristic equal to the stated figure in the «Recommended installation» document.

For equipments connected to IT distribution power system, the protection will be four poles in order to break the lines and neutral in the same manoeuvring.

Overload condition is considered as a nonpermanent and exceptional operating mode, so these currents will not be kept in mind when sizing the protection.

- The output protection will be a circuit breaker with the characteristic equal to the stated figure in the «Recommended installation» document.
- Depending on the model of the stabilizer, some control connections can be accessible from the rear of the equipment. Nevertheless any power connection is protected by a cover and those models in cabinet, it is needed to open the door too. When the corresponding tasks are finished, the terminal cover will be put back together with their fixing screws and those models in cabinet and front door, the door will be closed by means of the foreseen mechanisms.
- It is recommended to use spade terminals in all the cables connected to terminals.
- Check the correct torque of terminal screws.

5.3.1. Connection of input terminals.

-  As this is an equipment with class I protection against electrical shocks, it is essential to install the protection earth conductor (connect earth ). Connect this conductor, before supplying voltage to the input terminals.

- In three phase stabilizers consisting of single phase equipments, it is needed and essential to make one of these two options as regards to the earth:

- Joint the earth terminals (screws) **(X5)** of the three equipments by means of the cable and connect the protective earth cable coming from the installation to any of the terminals **(X5)**.

- Or come with one separate earth cable to each terminal (screw) **(X5)** of each equipment, but they have to come from the same point.

- Depending on the model of stabilizer, the power supply connections are directly done to the terminals or to the own rods of the input switch or breaker.

The illustrations corresponding to models in cabinet (Fig. 4 to 11), are shown with direct connection over the manoeuvring mechanism as a mere example.

Models with no terminals, the connection order will not differ from the one stated in Fig. 4 to 11, unless the labelling of the equipment states it.

- Connect the power supply cables to input terminals **(X1)** and **(X4)** in single phase equipments or **(X1)**, **(X2)**, **(X3)** and **(X4)** in three phase equipments, by respecting the phase rotation R or R-S-T and neutral **N** stated in the labelling of the equipment and this manual. If this sequence is not respected, serious damages will occur in the equipment.



In three phase equipments with delta connection, the neutral terminal **(X4)** is not available.

- In three phase stabilizers consisting of three single phase cabinets, in case it was requested to have one single point to connect the neutral, joint the neutral rod of the three equipments by means of the two extensions copper rods **(PT)**. Otherwise connect the suitable cross cable section to the three terminals **(X4)** corresponding to the neutral of each equipment.

When it is not a conditioning (only one conductor), it is able to connect a suitable cross cable section to the input neutral terminal **(X4)** of each equipment.

- In case of discrepancies between the labelling and the instructions of this manual, the labelling will always prevail.

5.3.2. Connection of output terminals.

-  As this is an equipment with class I protection against electrical shocks, it is essential to install the protection earth conductor (connect earth ). Connect this conductor, before supplying voltage to the input terminals.

- Depending on the model of stabilizer, the load or loads connections are directly done to the terminals or to the own rods of the manual switch option, if it is included.

The illustrations corresponding to models in cabinet (Fig. 4 to 11), are shown with direct connection over the manual bypass manoeuvring mechanism as a mere example. For those models without this option, there will always be a terminal strip.

Models with no terminals, the connection order will not differ from the one stated in Fig. 4 to 11, unless the labelling of the equipment states it.

- Connect the cables to supply the loads or loads to the output terminals **(X6)** and **(X9)** in single phase equipments or **(X6)**, **(X7)**, **(X8)** and **(X9)** in three phase equipments, by respecting the phase rotation U or U-V-W and neutral **N** stated in the labelling of the equipment and this manual.

Pay attention to the neutral connection in a three phase

unit with star configuration, because if the line is connected instead of the neutral, the load will suffer a high over voltage that can destroy it.

In three phase equipments with delta output, the neutral terminal **(X9)** is not available.

- In three phase stabilizers consisting of three single phase cabinets, in case it was requested to have one single point to connect the neutral, joint the neutral rod of the three equipments by means of the two extensions copper rods **(PT)**, otherwise connect the suitable cross cable section to the three terminals **(X9) corresponding to the neutral of each equipment.**

When it is not a conditioning (only one conductor), it is able to connect a suitable cross cable section to the output neutral terminal **(X9)** of each equipment.



- In case of discrepancies between the labelling and the instructions of this manual, the labelling will always prevail.
- With respect to the protection that must be placed at the output of the stabilizer, we recommend that the output power should be distributed in four lines, at least. Each one of them should have a circuit breaker protection switch of a quarter of the nominal power. This type of output power distribution will allow, in the event of a breakdown in any of the machines connected to the equipment that causes a short-circuit, will only affect to the line that is faulty.

The rest of the connected loads will have their continuity assured due to the tripping of the protection of the line affected by the short-circuit only.

5.3.3. Non-critical loads connection.

- Equipments with «Non-critical» loads contactor there will be two output terminal strips. Connect the loads to the corresponding group according to their topology, and attending to the labelling.

5.3.4. Connection of the protective earth .

-  As this is an equipment with class I protection against electrical shocks, it is essential to install the protection earth conductor (connect earth ). Connect this conductor, before supplying voltage to the input terminals.
- Make sure that all the loads connected to the stabilizer, the protective earth is only connected to this point. The fact of not respecting the protective earth connection of the load or loads to this single point, will create backfeed loops to earth that will affect to the quality of the power supplied.
- Regardless of the equipment has one or two protection earth terminals, are always joined to the ground of the stabilizer.
- In three phase stabilizers consisting of single phase equipments, it is needed and essential to make one of these two options as regards to the earth :
 - Joint the earth terminals (screws) **(X5)** of the three equipments by means of the cable and connect the protective earth cable coming from the installation to any of the terminals **(X5)**.

- Or come with one separate earth cable to each terminal (screw) **(X5)** of each equipment, but they have to come from the same point.

5.3.5. Connection of the communication module.

- Any connection is defined and related in the user's manual EN030*00 of the communication module. Make the corresponding connections.

5.3.6. Connection of the budgeted dry contacts option to terminals.



- Section 4.7.7 states the signal or alarms layout supplied through the terminal strip.

Use the suitable cross cable section for the needed voltage and current, attending the maximum ones that the contacts can handle.

5.3.7. SICRES Ethernet communication card.

To connect the SICRES card, pay attention to the instructions of the user's manual EK764*0, supplied together with the documentation CD-ROM of the own SICRES card.

5.3.8. Connection between an external manual Bypass Panel, stabilizer and loads.

-  As this is an equipment with class I protection against electrical shocks, it is essential to install the protection earth conductor (connect earth ). Connect this conductor, before supplying voltage to the input terminals of the manual Bypass Panel.

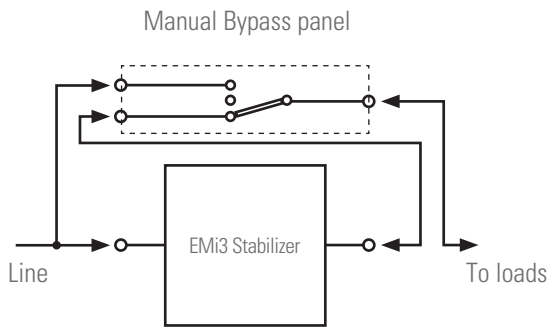

Fig. 15. Connection of the stabilizer with a manual Bypass Panel with single cam switch.

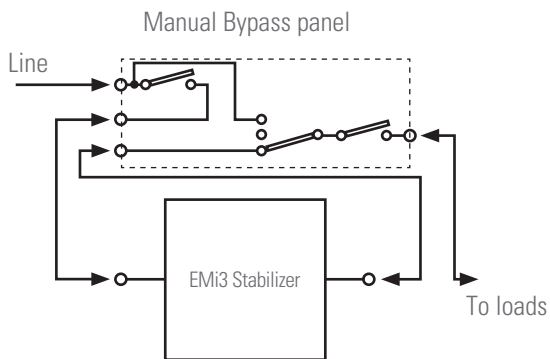

Fig. 16. Connection of the stabilizer with a manual Bypass Panel with single cam switch and protections.

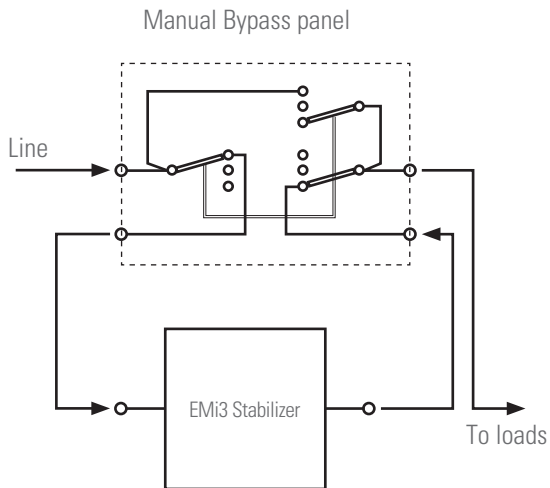

Fig. 17. Connection of the stabilizer with a manual Bypass Panel with double cam switch.

- Connections between the Bypass panel and power supply, stabilizer and loads will depend on the type of the cam switch and protections: single (see Fig. 15), if protections switches are available (see Fig. 16) or double (see Fig. 17).

The fact of having or not output switch will have no consequences for the connection.

- The manual Bypass Panel will be connected with the power supply, stabilizer and loads, by respecting the phase/s rotation and neutral N and the protective earth cable stated in the label-

ling of all of them.

- In case of discrepancies between the labelling and the instructions of this manual, the labelling will always prevail.

6. OPERATING.

6.1. CONTROLS BEFORE COMMISSIONING.

- Make sure that all the connections have been made properly and sufficiently tight, respecting the labelling of the equipment and instructions of section 5.

- Check that start up switch of the stabilizer (**Q1**) is in «0» or «Off» position.

In three phase equipments consisting of three single phase cabinets, check that all the switches (**Q1**) corresponding to the three phases are in «0» or «Off» position.

Otherwise turn it to this position.

- In equipments with the manual Bypass switch option (**Q5**), the preset position from factory of this switch is «0» (Out of service). Turn the cam switch to position «2» (Stabilizer).

In case the switch (**Q5**) were at position «1» (Bypass), turn it to position «2» (Stabilizer).

In three phase equipments consisting of three single phase cabinets with the manual Bypass option, each one of them will have a two poles switch (**Q5**). Put all of them to position «2» (Stabilizer).

- Check that the loads are shutdown.

6.2. START UP AND SHUTDOWN OF THE STABILIZER.

6.2.1. First commissioning procedure.

- When starting up the equipment for first time and only once, the installation menu is activated automatically in the control panel, by default is shown «ENGLISH». Through this menu the language of the messages displayed in the control panel is preset, as well as the input and output nominal voltages.

In equipments with special voltages (voltages different from the displayed in the menus shown in this section), the language will only be set because the equipment is already preset from factory to the requested voltage values.

- It is understood as «Start», that the stabilizer is connected to the electrical mains, with the correct voltage at the input terminals and the (**Q1**) switch turned «On».
- In case of selecting and validating any parameter wrongly, it will not be possible to activate the installation menu again, but the language can be changed through the control panel (see description in «Screen 4.9» of section 7.3.5).
- The adjustable voltage values that the end-user can select will depend on the structure of the own equipment and the metering of the input voltage (single or three phase and high or low voltage), being not able to select different ranges than the foreseen for each case as regards of them.

6.2.1.1. Procedure

- Turn the input switch of the switchgear panel «On».
- Turn the input switch (**Q1**) «On» of the stabiliser. The following message will be displayed:



Press the «**ENT**» key to enter in the language menu: English, Catalan, French and Spanish. By default the selected language is «ENGLISH».

Select the required one by means of the key «**▶**» or «**◀**», validate with «**ENT**» key and move forward to the next menu with the «**▼**» key.

The next menu the nominal input voltage can be selected. Depending on the equipment if it is single or three phase and high or low voltage, different values are shown to be selected. The highlighted values in this document in each menu are the values already preset from factory respectively.

SINGLE PHASE EQUIPMENT		THREE PHASE EQUIPMENT			
-VOLTAGE-		-VOLTAGE-			
LOW	HIGH	LOW (λ)	LOW(Δ)	HIGH (λ)	HIGH (Δ)
120 V	220 V	120 V	208 V	220 V	380 V
127 V	230 V	127 V	220 V	230 V	400 V
133 V	240 V	133 V	230 V	240 V	415 V
138 V		138 V	240 V		

Select the required value by means of the key «**▶**» or «**◀**», validate with «**ENT**» key and move forward to the next menu with «**▼**» key.

In the next menu the nominal output voltage of the stabilizer is selected. The values to select and the way to operate is the same as the used in the input voltage menu.

To end the message «**ESCAPE**» is shown, by default it is displayed with the option «**NO**», move with the «**▶**» or «**◀**» keys, to display «**YES**» and validate with «**ENT**» key. The LCD panel shows the main screen of the equipment

6.2.2. Start up.

- Turn to position «I» or «On» the input and/or output switch located in the protection panel.

Select the language of the LCD panel.

- Turn to position «I» or «On» the input circuit breaker or switch (**Q1**) of the stabilizer and wait 10 s before starting up the load or loads, in order to leave time to the stabilizer to sense and adjust the output voltage to their nominal values.

In three phase equipments consisting of three single phase cabinets, turn to position «I» or «On» the input circuit breaker or switch (**Q1**) in each equipment.

It is always recommended to wait 10 s, when the input circuit breaker or switch **(Q1)** is turned to position «I» or «On», in order to give time to a supposed extreme correction of the input voltage.

- Start up the load or loads. The equipment is ON.

6.2.3. Shutdown of the stabilizer.

- Shutdown the load or loads.
- Turn to position «0» or «Off» the input circuit breaker or switch **(Q1)** of the stabilizer.

In three phase equipments consisting of three single phase cabinets, turn to position «0» or «Off» the input circuit breaker or switch **(Q1)** in each equipment.



Do not use the input circuit breaker of the stabilizer **(Q1)** as a general ON/OFF switch of the loads and absolutely DO NOT use them for this function when they are isolators, because they are not built in to break current.

- Turn to position «0» or «Off» the input and/or output switch located in the protection panel.

6.3. BYPASS MANUAL, OPTION.

6.3.1. Load power supply from mains through the manual Bypass.

- Shutdown the load and stabilizer as section 6.2.3 states.
- Turn the manual Bypass switch option **(Q5)**, to position «1» (Bypass). The stabilizer will be out of service and ready for its maintenance or fixing in case of fault.

In three phase equipments consisting of three single phase cabinets with the manual Bypass option, turn the switch **(Q5) of each one of them to position «1» (Bypass).**

- Start up the loads, they will be directly supplied from commercial mains.

If the stabilizer has an additional isolation transformer, the loads will be supplied from the output of it, in order to take advantage of its intrinsic features.

-  The manual bypass switch cannot break current/load, so it is reminded that any action over it will make a break in the loads as it is break before make type and also because it shifts through the position «0».

6.3.2. Supply the loads through the stabilizer.

Once the maintenance or fixing tasks have been finished and in order to leave the stabilizer in operation again, proceed as follows:

- Shutdown the loads.
- Turn the manual Bypass switch option **(Q5)**, to position «2» (Stabilizer).

In three phase equipments consisting of three single phase cabinets with the manual Bypass option, turn the switch **(Q5) of each one of them to position «2» (Stabilizer).**

- Start up the stabilizer according to section 6.2.2.

6.4. MANUAL BYPASS PANEL, OPTION.

- In the start up and shutdown procedure of the stabilizer are described the actions to take with the input and/or output switches of the stabilizer protection panel.

The manual Bypass Panel can incorporate as a single part all these switches, besides of the own Bypass, so the start up and shutdown procedure of the stabilizer with a manual Bypass panel, if it has them, it is self-explanatory described when the start up and shutdown procedures refer to them.

6.4.1. Supply the loads from mains with the manual Bypass panel.

- Shutdown the load and stabilizer as section 6.2.3 states.
- Turn the manual Bypass switch to position «I» or «On».
- Start up the loads, they will be directly supplied from AC mains.

6.4.2. Supply the loads from the stabilizer.

- Shutdown the loads.
- Turn the manual Bypass switch to position «0» or «Off».
- Start up the stabilizer according to section 6.2.2.

7. CONTROL PANEL.

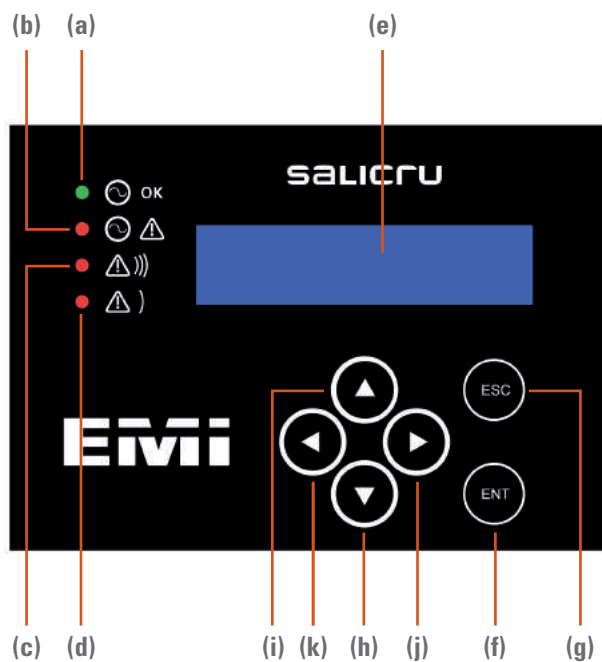

Fig. 18. Control panel with LCD.

- Basically the control panel is made by LED indicators, LCD of 2x16 characters and keypad of 6 keys.

7.1. LED OPTIC INDICATORS AND ALARM.

- (a) Correct output voltage LED indicator (green colour). It lights when the output voltage is inside the voltage range. With wrong output voltage the LED will be off.
- (b) Input voltage out of range LED indicator (red colour). It lights to show the status of the input as an alarm mode.
- (c) Urgent alarm LED indicator (red colour). It lights when the output voltage is out of range and/or there is a motor failure in any Variac.
- (d) Non-urgent alarm LED indicator (red colour). It lights as a general alarm mode.

The visual alarms indicators (b), (c) and (d) can be supplied as dry contacts alarms with the option communication module (see user's manual EN030*00).

Also, the equipment has an acoustic alarm, which is activated with any of the displayed alarms in the screen of the LCD panel. The alarm is disabled when acknowledged, so when ENT key is pressed for any active alarm.

It is not possible to silent forever and general the acoustic alarm.

7.2. BASIC FUNCTIONS OF THE KEYS AND NOTES.

- (e) LCD panel.
 - (f) «ENT» key.
 - (g) «ESC» key.
 - (h) Upward key «▲».
 - (i) Backward key «◀».
 - (j) Right key «▶».
 - (k) Left key «◂».
- By means of the upward «▲» and backward «◀» keys, there is access to the screens chained to the root menu, being able to move from one to another with themselves.
 - The right «▶» and left «◂» keys are used to move inside each submenu.
 - The «ENT» key, has two functions:
 - To enter into the submenus.
 - To acknowledge an alarm.
 - When pressing the «ESC» key, allows going back to main screen, regardless where we are.
 - The screen map of Fig. 19 and 20 are exploded with all submenus of the single and three phase equipments, even with the ones protected by «Password». Keep in mind this notes:
 - All the screens has a number reference, in order to be described or explained later on. Also some of them includes a number between brackets at the opposite site to the number reference, which are referred to enable a determined option or a restricted level. This same numbering is used in table 9 to identify the alarms related to the options.
 - ⁽³⁾ Output current metering option.
 - ⁽⁴⁾ Maximum-minimum protection option.
 - ⁽⁵⁾ Communication option.
 - ⁽⁶⁾ Non-critical loads disconnection option.
 - ⁽⁷⁾ Screens hidden by Password. This safety level avoids that non-authorized personnel can change any setting.
 - In some screens, the maximum number of characters of numerical or alphanumeric values is represented with the «x», each one of them corresponds to one character.
 - It is not foreseen that the end-user can modify the preset settings protected with «Password».

In case of requiring any modification or setting, contact with our Service and Technical Support (S.T.S.).

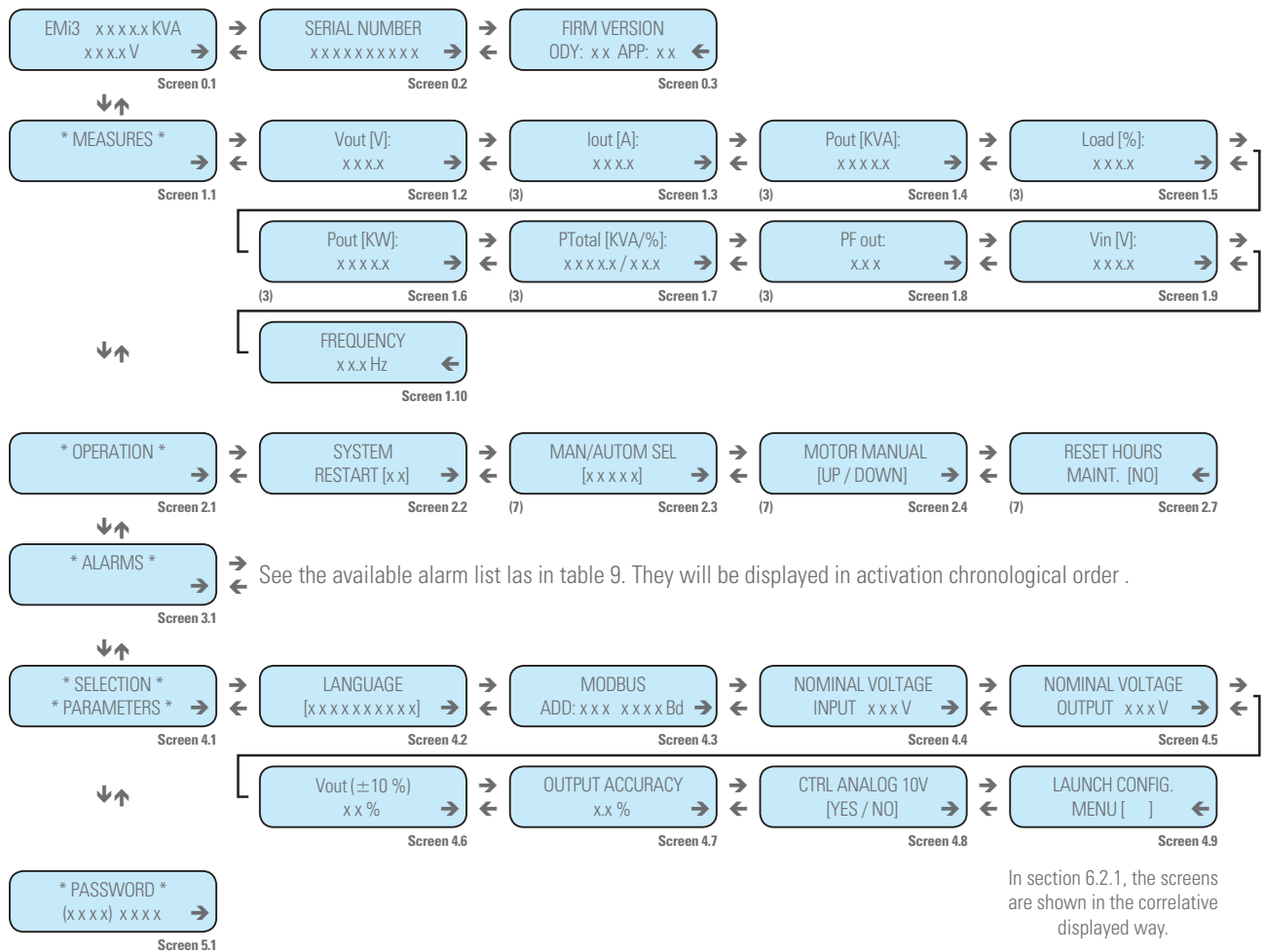

Fig. 19. Single phase stabilizer screen map.

7.3. DESCRIPTION OF THE SCREENS.

7.3.1. «Start» screen menu.

Screen 0.1

This is the main screen of the system, which is displayed as soon as the equipment is started. Also, it is the displayed screen when the (ESC) key is pressed in order to escape from any of the menus or submenus of the control panel with LCD.

It is shown the stabilizer family, apparent power of the model and output voltage.

Screen 0.2

This screen shows the serial number of the equipment.

Screen 0.3

This screen shows the software version of the equipment.

7.3.2. «Measures» menu.

To access from main screen press once the upward (↑) key. By means of the (▶) key there is access to any screen of the

submenus, being able to move freely from one to another with the (▶) or (◀) keys.

Screen 1.1

Main screen of Measures menu.

Screen 1.2

It shows the output voltage of the equipment. It shows the three phase voltages for a three phase equipments.

Screen 1.3

It shows the output current of the equipment. It shows the three phase current for a three phase equipment.

Screen 1.4

It shows the output apparent power of the equipment. It shows the three phase output apparent power for a three phase equipment.

Screen 1.5

It shows the output load percentage of the equipment. It shows the three phase output load percentage for a three phase equipment.

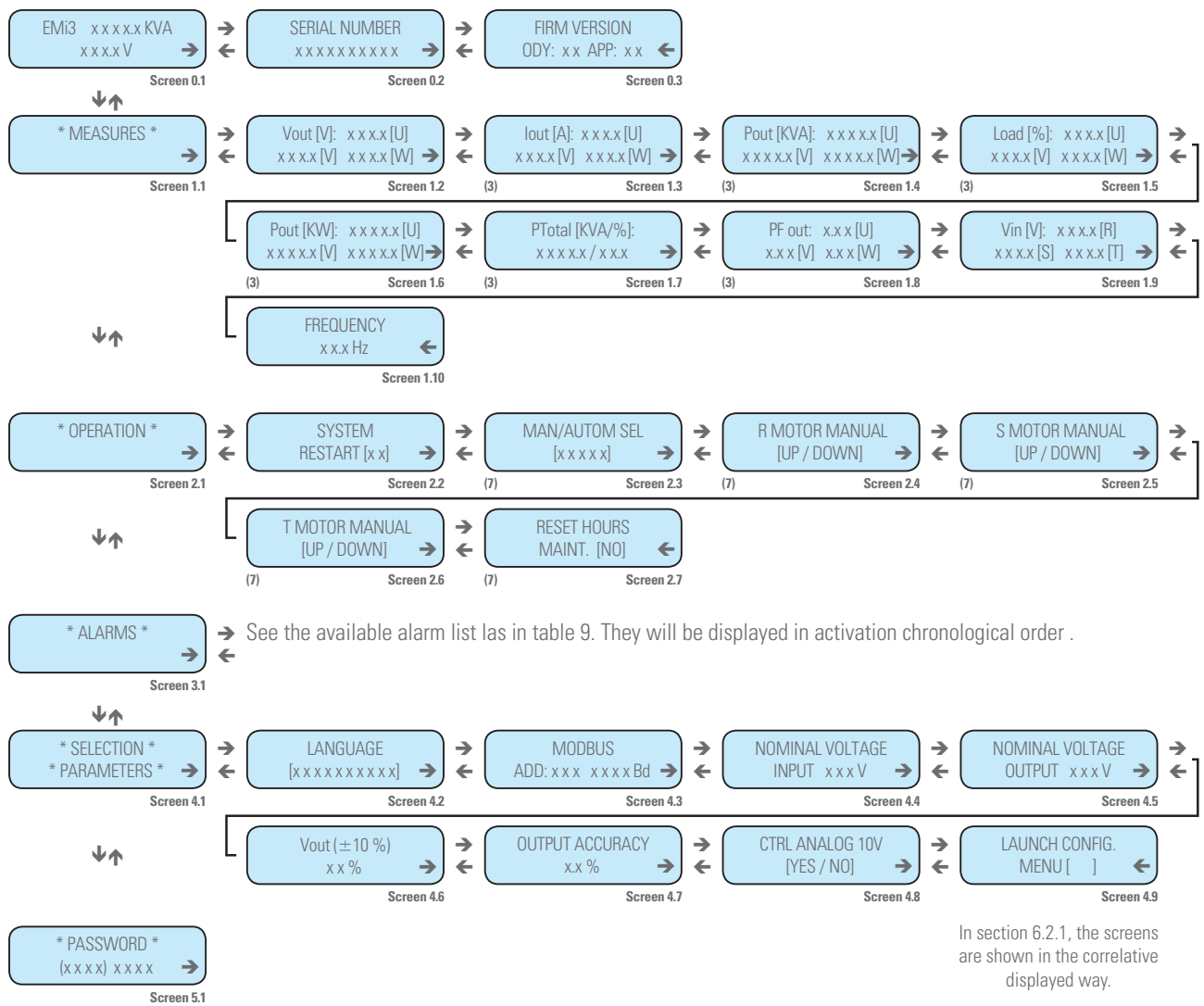

In section 6.2.1, the screens are shown in the correlative displayed way.

Fig. 20. Three phase stabilizer screen map.

Screen 1.6

It shows the output active power of the equipment. It shows the three phase output active power for a three phase equipment.

Screen 1.7

It shows the total output apparent power and the total output load percentage of the equipment.

Screen 1.8

It shows the load output power factor of the equipment. It shows the three phase output power factor for a three phase equipment.





Screen 1.9

It shows the input voltage of the equipment. It shows the three phase input voltage for a three phase equipment.

Screen 1.10

It shows the input frequency of the equipment.

7.3.3. «Operation» menu.

To access from main screen press twice the upward «» key. By means of the «» key there is access to any screen of the submenus, being able to move freely from one to another with the «» or «» keys.

Screen 2.1

It is the gateway to the operation menu.

Screen 2.2

Manual rearming in case the stabilizer is blocked.

Screen 2.3

Motor move selection, manual or automatic (regulation at nominal voltage). In case of Manual selection, the motor is moved through the screen 2.4 in single phase equipments or through the screens 2.4, 2.5 and 2.6 in three phase equipments.

Screen 2.4

With Manual selection, the screen 2.3, supplies voltage to the motor in clock or counter clock wise in order to increase or decrease the voltage by means of «▲» or «▼» keys respectively. In three phase equipments with independent phase regulation, it is used for phase R and in stabilizers with common regulation, the regulation is applied to the three phases.

Screen 2.5

In three phase equipments with independent phase regulation and Manual selection in the screen 2.3, it supplies voltage to the motor of phase S in order to increase or decrease the output voltage with «▲» or «▼» keys respectively.

Screen 2.6

In three phase equipments with independent phase regulation and Manual selection in the screen 2.3, it supplies voltage to the motor of phase T in order to increase or decrease the output voltage with «▲» or «▼» keys respectively.

Screen 2.7

The preventive maintenance timer is reset..

7.3.4. «Alarm» menu.

To access from main screen press three times the upward «▼» key. By means of the «▶» key there is access to any screen of the submenus, being able to move freely from one to another with the «▶» or «◀» keys

Screen 3.1

It is the gateway to the Alarm menu.

Table 9 shows the different available alarms in a EMI3 stabilizer, they will be displayed in chronological activation order. Pay attention, if the equipment is single or three phase, because the number of alarms is higher in the second one because there more lines.

Keep in mind that some alarms are only available when the equipment includes the option.

7.3.5. «Parameter selection» menu.

To access from main screen press four times the upward «▼» key. By means of the «▶» key there is access to any screen of the submenus, being able to move freely from one to another with the «▶» or «◀» keys.

Screen 4.1

It is the gateway to the Parameter menu.

Screen alarm	Description	Enabling level
ALARM INPUT VOLTAGE HIGH	Input voltage higher than the nominal + the high range.	In single phase equipment.
ALARM INPUT VOLTAGE HIGH R	Phase R input voltage higher than the nominal + the high range.	In three phase equipment
ALARM INPUT VOLTAGE HIGH S	Phase S input voltage higher than the nominal + the high range.	In three phase equipment
ALARM INPUT VOLTAGE HIGH T	Phase T input voltage higher than the nominal + the high range	In three phase equipment
ALARM INPUT VOLTAGE LOW	Input voltage lower than nominal – the low range.	In single phase equipment.
ALARM INPUT VOLTAGE LOW R	Phase R input voltage lower than the nominal – the low range.	In three phase equipment
ALARM INPUT VOLTAGE LOW S	Phase S input voltage lower than the nominal – the low range.	In three phase equipment
ALARM INPUT VOLTAGE LOW T	Phase T input voltage lower than the nominal – the low range.	In three phase equipment
ALARM OVERLOAD	Load connected at the output higher than 100 %. Single phase equipment only	In single phase equipment + (3)
ALARM OVERLOAD R	Load connected at the output of phase R higher than 100 %.	In three phase equipment + (3)
ALARM OVERLOAD S	Load connected at the output of phase S higher than 100 %.	In three phase equipment + (3)
ALARM OVERLOAD T	Load connected at the output of phase T higher than 100 %.	In three phase equipment + (3)
ALARM OUTPUT VOLTAGE HIGH	Output voltage higher than nominal + high accuracy.	In single phase equipment
ALARM OUTPUT VOLTAGE HIGH R	Phase R output voltage higher than nominal + high accuracy.	In three phase equipment
ALARM OUTPUT VOLTAGE HIGH S	Phase S output voltage higher than nominal + high accuracy.	In three phase equipment
ALARM OUTPUT VOLTAGE HIGH T	Phase T output voltage higher than nominal + high accuracy.	In three phase equipment
ALARM OUTPUT VOLTAGE LOW	Output voltage lower than nominal – low accuracy.	In single phase equipment
ALARM OUTPUT VOLTAGE LOW R	Phase R output voltage lower than nominal – low accuracy.	In three phase equipment
ALARM OUTPUT VOLTAGE LOW S	Phase S output voltage lower than nominal – low accuracy.	In three phase equipment
ALARM OUTPUT VOLTAGE LOW T	Phase T output voltage lower than nominal – low accuracy.	In three phase equipment
ALARM FAIL MOTOR	The stabilizer is not at the limit and it can't stabilize.	In single phase equipment
ALARM FAIL MOTOR R	The stabilizer is not at the limit and it can't stabilize the phase R or the three phases for common regulation three phase equipments.	In three phase equipment
ALARM FAIL MOTOR S	The stabilizer is not at the limit and it can't stabilize the phase S in an independent phase regulation equipment.	In three phase equipment
ALARM FAIL MOTOR T	The stabilizer is not at the limit and it can't stabilize the phase T in an independent phase regulation equipment.	In three phase equipment

Screen alarm	Description	Enabling level
ALARM FAIL SYSTEM FILE	Parameter system not coherent.	Any.
ALARM FAIL MAINTENANCE	Notification of needing for preventive maintenance.	Any
ALARM RELAY OVERLOAD	Overload relay activated because the load is higher than 100 %.	(3).
ALARM RELAY MAX-MIN	Maximum-minimum relay activated because it is out of range.	(4).
ALARM DIGITAL INPUT A	The external digital output has been activated.	(5).
NON PRIOTARY LOADS DISCONNED.	Non-critical load level has been exceeded.	(6).

Tabla 9. Available alarm list depending on the model.

Screen 4.2

Selection of the language of the LCD panel messages: English, French, Catalan and Spanish.

Screen 4.3

Setting of MODBUS address of the equipment and Baud rate.

Screen 4.4

Reading the input nominal voltage.

Screen 4.5

Reading the output nominal voltage.

Screen 4.6

Output voltage set point setting in %. This setting modifies the preset nominal output voltage to a higher or lower value.

Screen 4.7

Output voltage accuracy setting, which can be adjusted between 0,5 and 5 %.

Screen 4.8

Analogical control selection. When selecting «YES» the output voltage will be set between a minimum and maximum voltage range according to the 0...10 V reference voltage input setting.





Screen 4.9

Access to the setting screens of the equipment when it is implemented an upgraded firmware from version 104. By means of the screen 4.9, the selected voltages done in the installation menu can be changed and corrected the wrong selections or even to set the equipment for a new installation.

The voltage values that the end-user will be able to select in the setting menu for a single or three phase structure and high or low voltage will depend in the constructive features of the equipment.

Any different value from the standard setting is already set from factory, so the screens to select the input and output voltages will not be available in the installation menu. It is understood as NON STANDARD, those voltage values different from the ones stated in the screen 4.4, because under request the equipments can be manufactured with other voltages with their respective LCD panel metering.

7.3.6. «Password» menu.

To access from main screen press 5 times the move forward «» key. By means of the «» key there is access to the different screens of its submenus, being able to move freely from one to another by means of the «» or «» keys.

Screen 5.1

Access to the screens protected by password. **T.S.S.** staff has only access to these screens.

8. MAINTENANCE, WARRANTY AND SERVICE.

8.1. BASIC TROUBLESHOOTING GUIDE FOR PREVENTIVE MAINTENANCE.

Using the EMI3 properly, they do not require so much attention. Nevertheless a periodic inspection from time to time due the wear in some parts and operating conditions is recommended.

8.1.1. Annual inspection.

8.1.1.1. General.

- Check the transmission system of the Variac is still aligned. Correct if it is needed. ⁽⁸⁾
 - Check that the movement of the Variac is uniform (no vibrations and no steps).
Probably, it is required the replacement of the motor or gear system. ⁽⁸⁾
 - Check that the limit switches work properly.
Probably, it is required the replacement of the limit switch. ⁽⁸⁾
- ⁽⁸⁾  In case it is needed to take actions in an equipment, call to our Service and Technical Support **(S.T.S.)**.

8.1.1.2. Brushes.

- Check the free move of the brushes.
Probably, it is required the replacement of the brush. ⁽⁸⁾
 - Check the contact surface is smooth.
Probably, it is required the replacement of the Variac. ⁽⁸⁾
 - Check the pressure over the winding through the spring is correct.
Probably, it is required the replacement of the brush spring. ⁽⁸⁾
- ⁽⁸⁾  In case it is needed to take actions in an equipment, call to our Service and Technical Support **(S.T.S.)**.

8.1.1.3. Advices.

- It is advisable to clean the track with a wet cloth in alcohol and check that it is smooth without any deformation. This action can only be done with the equipment completely shutdown (no voltage).

8.1.1.4. Particular cases.

- If the EMI3 has been out of order for long time and without any protection coat, it is better to clean the dust placed in the track before starting up the equipment.
- If the stabilizer is installed in a corrosive environment or with a lot of dust, it is important to clean the track and brushes holder regularly with a cloth damped with alcohol. This action can only be done with the equipment completely shutdown (no voltage).

- If the EMI3 has a serious overload, the coal of the brush can be damaged, even if there is not any visible damage in the winding. ⁽⁹⁾

⁽⁹⁾  Contact with our Service and Technical Support **(S.T.S.)** to proceed to replace the brush before starting up the Stabilizer.

Besides of the preventive checking shown in this document, for any other problem or doubt about the operating of the stabilizer, contact with our Service and Technical Support **(S.T.S.)**.

8.2. WARRANTY CONDITIONS.

8.2.1. Warranty terms.

The warranty conditions for the acquired product can be found in our website and in that you will be able to register it. It is recommended to do it as soon as possible in order to include it in the Service and Technical Support (S.T.S.) database. Among other advantages, it will be easier to make any regulatory process to allow the S.T.S action in case of any hypothetical fault.

8.2.2. Out of scope of supply.

Our company is not forced by the warranty if it appreciates that the defect in the product doesn't exist or it was caused by a wrong use, negligence, installation and/or inadequate testing, tentative of non-authorized repairing or modification, or any other cause beyond the foreseen use, or by accident, fire, lightnings or other dangers. Neither it will cover, in any case, compensations for damages or injuries.

8.3. TECHNICAL SERVICE NETWORK.

Coverage, both national and international, from our Service and Technical Support **(S.T.S.)**, can be found in our Website.

9. ANNEXES.

9.1. STANDARD EQUIPMENTS GENERAL TECHNICAL SPECIFICATIONS.

Input	
Voltage	Single phase 220 / 230 or 240 V (phase + neutral and PE) Three phase 3x380 / 3x400 / 3x415 V (3 phases + neutral and PE) Other voltages and configurations under request
Range	± 15 % as standard and under request up to ± 30 %
Frequency	48.. 63 Hz
Output	
Voltage	Single phase 220 / 230 or 240 V (phase + neutral and PE) Three phase 3x380 / 3x400 / 3x415 V (3 phases + neutral and PE) Other voltages and configurations under request
Accuracy	± 1 % (adjustable between 1.. 5 %)
Output voltage adjustment	± 10 %
Frequency	48.. 63 Hz
Response time	Up to 70 V/s
Efficiency	96.5.. 97.5 %
Voltage harmonic injection	< 0.2 %
Disconnection voltage value	Adjustable (With Maximum-Minimum protection only)
Permissible overload	Up to 200 % for 20 s
Possible load fluctuation	0.. 100 %
Power facgtor influence	Independent
Indications	
At the front of the equipments	Control panel with LCD of 2x16 characters + 4 LEDs of status
Communications	
RS232 serial port and Slot for SICRES	Standard or optional depending on model (see table 1, 3, 5 and 7)
Two dry contact to terminals	Option
SICRES card	Option
Communication module	Option
Generals	
Operating temperature	- 10.. + 55 °C
Storage temperature	- 20.. + 85 °C
Cooling	Natural or forced cooling depending on the model
Acoustic noise level at 1 m	<45 dB(A) and models with forced cooling <65 dB(A)
Relative humidity	Up to 95 % non-condensing
Maximum operating altitude	2.400 m. a.s.l.
Dimensions and weight	See table 1 to 8
Mean Time Between Failures (MTBF)	60.000 h
Mean Time To Repair (MTTR)	30 min
Protection degree	IP20
Standards	
Safety	IEC/EN 62103
Electromagnetic Compatibility (EMC)	EN/IEC 61000-6-4; EN/IEC 61000-6-2
Marking	CE
Certification body	SGS
Quality and Environmental Management	ISO 9001 and ISO 140001

Tabla 10. General technical specifications.

