

FEC40W SERIES

DC / DC Single & Dual Output: 40 Watts



Features

- ◆ 4:1 wide Input range option 9~36V & 18~75V
- ◆ Single & Dual outputs
- ◆ Industry Standard 2 x 2 in package
- ◆ High efficiency up to 82%
- ◆ Regulated output & Short circuit protection
- ◆ 1600V isolation
- ◆ Five sided continuous copper shield
- ◆ Remote ON / OFF- Standard Positive Logic
- ◆ Remote ON / OFF- Negative Logic - Option
- ◆ High operating temperature +85°C
- ◆ Fixed switching frequency
- ◆ Optional heat sink: P/N : 7G-0026A.

Specifications:

Input Voltage	24VDC (9 ~ 36) 48VDC (18 ~ 75)	Overload Protection	Typically 150% of load
Input Filter	Pi type	Short Circuit protection	Continuous hiccup mode
Input Surge Voltage. (100mS)	24V: 50VDC. 48V: 100VDC	Efficiency	Model dependant 86 ~ 87%
Input Reflected Ripple Current	20mA pk-pk @ nominal input & 100% load	Isolation	1600VDC
Start Up time	10mS constant resistive load	Isolation Cap.	25000pF
Start Up Voltage	9V for 24VDC input models 18V for 48VDC input models	Switching Freq.	300KHz
Shutdown Voltage	8V for 24VDC input models 16V for 48VDC input models	Safety	EN60950-1, UL60950-1
Remote ON/OFF (Positive logic – Standard)	DC-DC ON Open or 3.0V < Vr < 12V DC-DC OFF Short or 0V < Vr < 1.2V	Case Material	Nickel-coated copper
(Negative logic – Option)	DC-DC ON Short or 0V < Vr < 1.2V DC-DC OFF Open or 3.0V < Vr < 12V	Base Material	Non-conductive black plastic
	Input current of remote control pin: .5mA Remote off state input current: 10mA for 24Vin 5mA for 48Vin	Potting	Epoxy UL94-V0
Output power	40 watts	Dimensions	50.8 x 50.8 x 10.2mm
Voltage Accuracy	±1.0%	Weight	60g
Minimum Load	See table	MTBF	1.511 x 10 ⁶ Hrs
Output Voltage Trim	±10% (single & Dual output)	Operating Temp	-40°C to +50°C (without derating) -40°C to +105°C (with derating)
Line Regulation	Single ±0.2% Dual ±0.2%	Case Temp	+100°C maximum case temperature
Load Regulation	Single ±0.5% , Dual ±1% (Min load -100% load)	Thermal Impedance	9.2°C / watt Standard convection 7.6°C / watt with optional heatsink
Cross Regulation	±5% Asymmetrical load: 25-100% load)	Thermal shock	MIL-STD-810F
Ripple & noise	See table. 20MHZ bandwidth	Vibration	10-55Hz, 10G, 30min along X, Y,Z
Temp. Coefficient	±0.02% / °C	Humidity	5-95% RH
Transient Response	250uS (25% load step change)	EMC	EN55022 Class A Consult office for Class B design
Over Voltage Protection	1.5V ~ 3.3V: 3.9V: 5.0V: 6.2V 12V: 15V 15V: 18V	ESD	EN61000-4-2 (Air ±8KV) (Contact ±6KV)
		Radiated Immunity	EN61000-4-3 10 V/m
		Fast Transients	EN61000-4-4 ±2KV
		Surge	EN61000-4-5 ± 1KV
		Conducted Immunity	EN61000-4-6 10 V rms

FEC40W SERIES

DC / DC Single & Dual Output: 40 Watts

Model	Input V	Output V	Output Current		Output Ripple & Noise	Input Current		Eff (%)	Capacitor Load max
			Min. load	Full load		No load	Full load		
FEC40-24S3P3W	9 – 36 V	3.3 V	0mA	10000mA	50mVp-p	80mA	1677mA	86	25750uF
FEC40-24S05W	9 – 36 V	5 V	0mA	8000mA	50mVp-p	100mA	2008mA	87	13600uF
FEC40-24S12W	9 – 36 V	12 V	50mA	3333mA	75mVp-p	50mA	2008mA	87	2360uF
FEC40-24S15W	9 – 36 V	15 V	50mA	2666mA	75mVp-p	50mA	2008mA	87	1510uF
FEC40-24D12W	9 – 36 V	± 12 V	±65 mA	± 1667mA	120mVp-p	60mA	2032mA	86	± 1200uF
FEC40-24D15W	9 – 36 V	± 15 V	±50 mA	± 1333mA	150mVp-p	60mA	2032mA	86	± 750uF
FEC40-48S3P3W	18 – 75 V	3.3 V	0mA	10000mA	50mVp-p	50mA	838mA	86	25750uF
FEC40-48S05W	18 – 75 V	5 V	0mA	8000mA	50mVp-p	60mA	992mA	88	13600uF
FEC40-48S12W	18 – 75 V	12 V	50mA	3333mA	75mVp-p	30mA	1004mA	87	2360uF
FEC40-48S15W	18 – 75 V	15 V	50mA	2666mA	75mVp-p	30mA	1004mA	87	1510uF
FEC40-48D12W	18 – 75 V	± 12 V	±65 mA	± 1667mA	120mVp-p	30mA	1016mA	86	± 1200uF
FEC40-48D15W	18 – 75 V	± 15 V	±60 mA	± 1333mA	150mVp-p	30mA	1016mA	86	± 750uF

Note

1. MTBF as per BELLCORE TR-NWT-000332. Case I: 50% Stress, Temperature at 40°C. (Ground fixed and controlled environment)
MIL-STD-217F Notice2 @Ta=25 °C, Full load(Ground, Benign, controlled environment)
2. Typical values at nominal input voltage and full resistive load.
3. The output requires minimum loading on the output to maintain specified regulation. Operation under no-load condition will not damage these devices, however they may not meet all listed specification.
4. For the single output: Maximum output deviation is 10% inclusive of remote sense and trim. If remote sense is not being used, the +sense should be connected to its corresponding +OUTPUT and likewise the -sense should be connected to its corresponding –OUTPUT.
5. Load regulation for dual output : Min load to 100% load balanced on all outputs.
6. Cross regulation for dual output : asymmetrical load 25% / 100% FL
7. The ON/OFF pin voltage is referenced to –Vin To order negative logic ON/OFF control add the suffix-**N** (eg: FEC40-24S05W-N).
8. Heat sink is optional and **P/N : 7G-0026A**.
9. The FEC40W series can meet EN55022 Class A with parallel an external capacitor to the input pins.
Recommend : 24Vin : N/A 48Vin :2.2uF/100V*2 PCS 1812 MLCC.
10. An external filter capacitor is required if the module has to meet EN61000-4-5.
Filter capacitor recommended: Nippon chemi-con KY series, 220µF/100V, ESR 48mΩ.

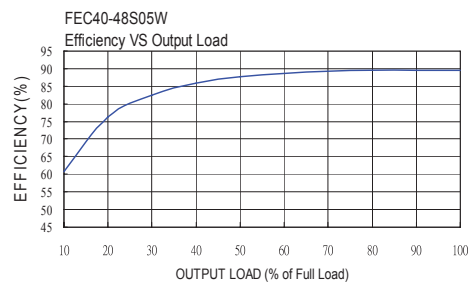
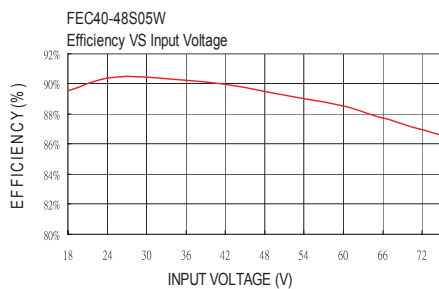
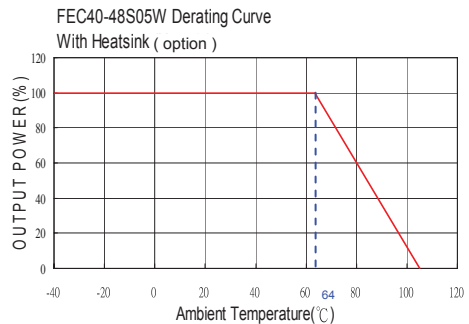
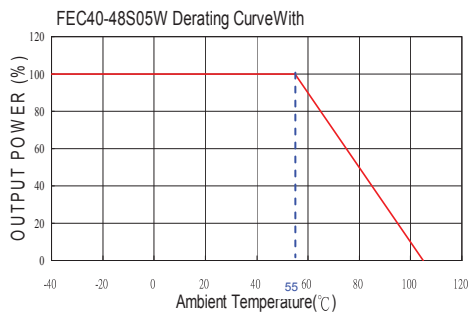

FEC40W SERIES

DC / DC Single & Dual Output: 40 Watts

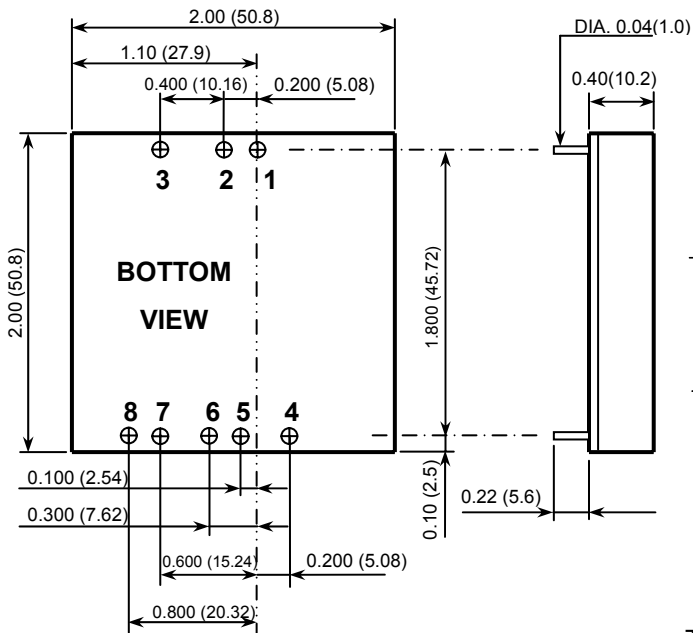

- All dimensions in Inches (mm)
Tolerance: X.XX±0.02 (X.X±0.5)
X.XXX±0.01 (X.XX±0.25)
- Pin pitch tolerance ±0.01(0.25)
- Pin dimension tolerance ±0.004 (0.1)

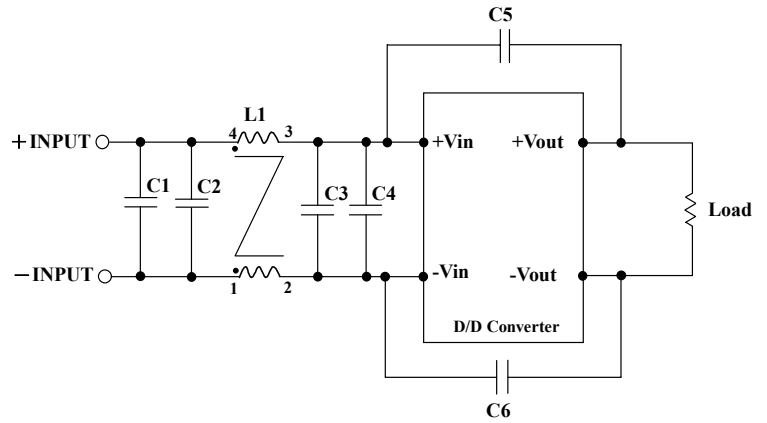

Recommended Filter for EN55022 Class B Compliance

The components used in the above figure, together with the manufacturers' part numbers for these components, are as follows:

	C1	C2	C3	C4	C5 & C6	L1
FEC40-24xxxW	4.7uF/50V 1812 MLCC	N/A	4.7uF/50V 1812 MLCC	N/A	1000pF/2KV MLCC	450uH Common Choke PMT-048
FEC40-48xxxW	2.2uF/100V 1812 MLCC	2.2uF/100V 1812 MLCC	2.2uF/100V 1812 MLCC	2.2uF/100V 1812 MLCC	1000pF/2KV MLCC	830uH Common Choke PMT-053

Pin Assignment		
PIN	SINGLE	DUAL
1	+INPUT	+INPUT
2	-INPUT	-INPUT
3	CTRL	CTRL
4	-SENSE	+OUTPUT
5	+SENSE	COM
6	+OUTPUT	COM
7	-OUTPUT	-OUTPUT
8	TRIM	TRIM

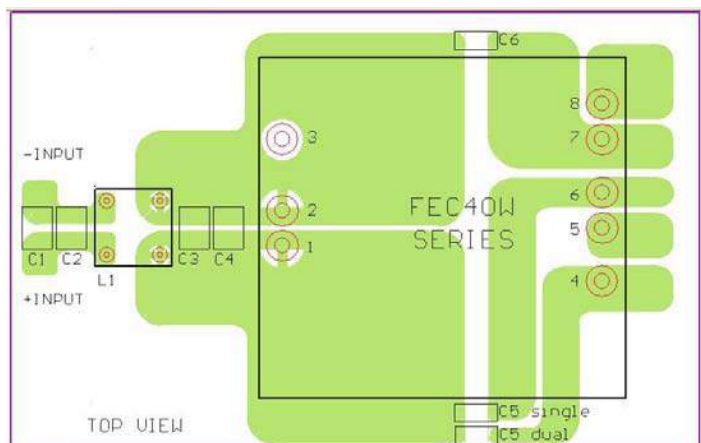
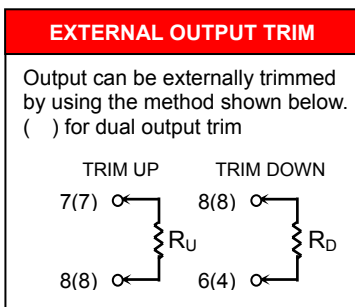

Recommended EN55022 Class B Filter Circuit Layout