

LCD15W SERIES

DC / DC Single & Dual Output: 15 Watts

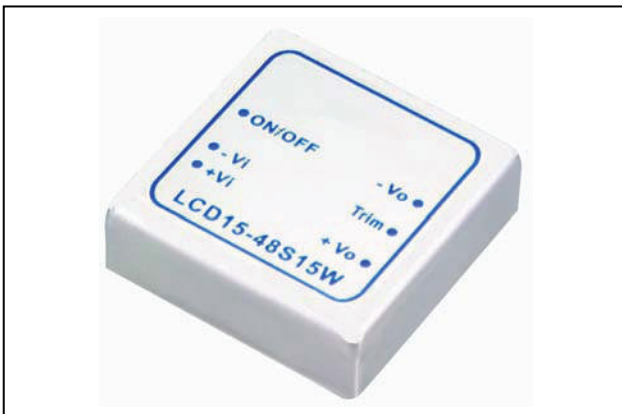

Features

- 4:1 Wide input range: 9 ~ 36V, 18 ~ 75V
- Single & Dual outputs
- Industry Standard 1 x 1in package @ 15W
- High efficiency up to 89%
- Regulated output & Short circuit protection
- 1600V isolation
- Five sided continuous copper shield
- Remote ON / OFF, Negative or Positive Logic
- High operating temperature +85°C
- Zero load operation
- Output voltage trim

Specifications:

Input Voltage	24VDC (9 ~ 36) 48VDC (18 ~ 75)
Input Filter	Pi type
Start-up Voltage	24V input: 9V typ. 48V input: 18V typ.
Input Surge Voltage. (100mS)	24V: 50VDC. 48V: 100VDC
Input Reverse Voltage Protection	External input fuse required
Input Reflected Ripple Current	30mA p-p
Start Up time	Typically 30mS constant resistive load
Remote ON/OFF Negative Logic - Standard	DC-DC ON Short or 0V < Vr < 1.2V DC-DC OFF Open or 3.0V < Vr < 15V
(Positive Logic - Option)	DC-DC ON Open or 3.0V < Vr < 15V DC-DC OFF Short or 0V < Vr < 1.2V
	Input current of remote control pin: 0.5mA Remote off state input current: 2.5mA
Output power	15 watts
Voltage Accuracy	±1.0%
Voltage Trim	±10% External voltage trim
Minim Load	Zero
Line Regulation	Single ±0.2%, Dual ±0.5%
Load Regulation	Single ±0.2%, Dual ±1.0%
Cross Regulation	Dual (±5% asymmetrical 25% to 100% FL)
Ripple & noise	See table. 20MHZ bandwidth
Temp. Coefficient	±0.02% / °C
Transient Response	250uS (25% load step change)
Over Voltage Protection	Set at 110 ~130% of Voltage output nominal
Overload Protection	Set at approx 150% of output load
Short Circuit protection	Continuous hiccup mode

Efficiency	Model dependant 84 ~ 89%
Isolation	Input – Output: 1600VDC Input / Output – Case: 1000VDC
Isolation Cap.	1000pF
Switching Freq.	400KHz
Safety	Designed to meet EN60950-1, UL60950-1
Case Material	Nickel-coated copper
Base Material	FR4 PCB
Potting	Epoxy UL94-V0
Dimensions	25.4 x 25.4 x 0.0mm
Weight	15g
MTBF	5.630 x 10 ⁵ Hrs
Operating Temp	-40°C to +85°C (with derating)
Case Temp	+105°C maximum case temperature
Over Temp. Protection	Shutdown approx 115°C case temperature
Thermal Impedance	18.2°C / watt without heatsink 15.8°C / watt with optional heatsink
Thermal shock	MIL-STD-810F
Vibration	MIL-STD-810F
Humidity	5-95% RH
EMC	EN55022 Class A (see note 9)
ESD	EN61000-4-2
Radiated Immunity	EN61000-4-3
Fast Transients	EN61000-4-4
Surge	EN61000-4-5
Conducted Immunity	EN61000-4-6

REV 19-09-08

LCD15W SERIES

DC / DC Single & Dual Output: 15 Watts

Model Number	Input Range	Output Voltage	Output Current		Output ⁽⁴⁾ Ripple & Noise	Input Current		Eff ⁽⁴⁾ (%)	Capacitor ⁽⁵⁾ Load max
			Min. Load	Full Load		No Load ⁽³⁾	Full Load ⁽²⁾		
LCD15-24S3P3W	9 - 36 V	3.3 V	0mA	4000mA	75mVp-p	50mA	688mA	86	1000μF
LCD15-24S05W	9 - 36 V	5 V	0mA	3000mA	75mVp-p	70mA	762mA	86	1000μF
LCD15-24S12W	9 - 36 V	12 V	0mA	1300mA	100mVp-p	20mA	783mA	87	330μF
LCD15-24S15W	9 - 36 V	15 V	0mA	1000mA	100mVp-p	20mA	753mA	87	220μF
LCD15-24D05W	9 - 36 V	± 5 V	0mA	± 1500mA	100mVp-p	20mA	772mA	85	± 500μF
LCD15-24D12W	9 - 36 V	± 12 V	0mA	± 625mA	100mVp-p	25mA	753mA	87	± 150μF
LCD15-24D15W	9 - 36 V	± 15 V	0mA	± 500mA	100mVp-p	25mA	744mA	88	± 100μF
LCD15-48S3P3W	18 - 75 V	3.3 V	0mA	4000mA	75mVp-p	40mA	336mA	86	1000μF
LCD15-48S05W	18 - 75 V	5 V	0mA	3000mA	75mVp-p	40mA	382mA	86	1000μF
LCD15-48S12W	18 - 75 V	12 V	0mA	1300mA	100mVp-p	15mA	392mA	87	330μF
LCD15-48S15W	18 - 75 V	15 V	0mA	1000mA	100mVp-p	15mA	377mA	87	220μF
LCD15-48D05W	18 - 75 V	± 5 V	0mA	± 1500mA	100mVp-p	15mA	386mA	85	± 500μF
LCD15-48D12W	18 - 75 V	± 12 V	0mA	± 625mA	100mVp-p	15mA	382mA	86	± 150μF
LCD15-48D15W	18 - 75 V	± 15 V	0mA	± 500mA	100mVp-p	20mA	377mA	87	± 100μF

Note

- BELLCORE TR-NWT-000332. Case 1: 50% Stress, Temperature at 40°C. MIL-HDBK-217F Notice2 @Ta=25 °C, Full load(Ground, Benign, controlled environment)
- Maximum value at nominal input voltage and full load.
- Typical value at nominal input voltage and no load.
- Typical value at nominal input voltage and full load.
- Test by minimum Vin and constant resistive load.
- Trimming allows the user to increase or decrease the output voltage set point of the module. This is accomplished by connecting an external resistor between the TRIM pin and either the +Vout pin or the -Vout pin.
- The ON/OFF control pin voltage is reference to -Vin. The order number please see product standard table.
- Heat sink is optional and P/N:7G-Q047C-F
- The LCD15W series can meet EN55022 Class A with parallel external capacitors to the input pins.
Recommend : 24Vin : 6.8μF/50V * 2 pcs 1812 MLCC
48Vin : 2.2μF/100V * 2 pcs 1812 MLCC
- An external input filter capacitor is required if the module has to meet EN61000-4-4, EN61000-4-5. The filter capacitor Power Mate suggest: Nippon chemi-con KY series, 220μF/100V, ESR 48mΩ.

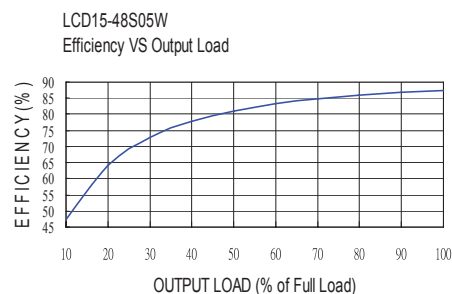
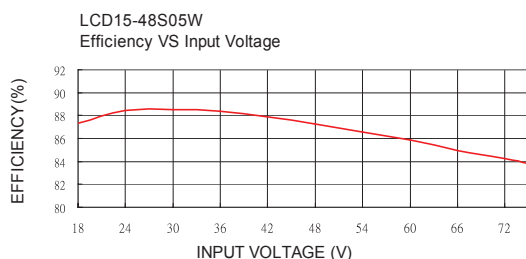
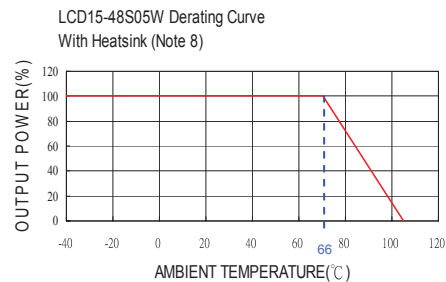
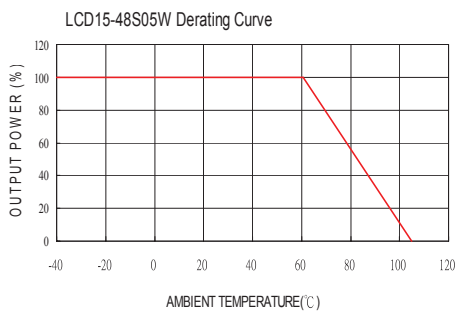

LCD15W SERIES

DC / DC Single & Dual Output: 15 Watts

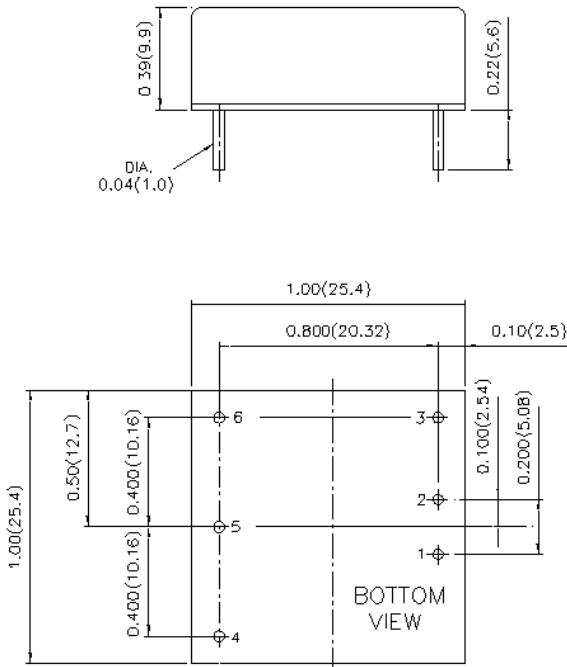

- All dimensions in Inches (mm)
Tolerance: X.XX±0.02 (X.X±0.5)
X.XXX±0.01 (X.XX±0.25)
- Pin pitch tolerance ±0.01(0.25)
- Pin dimension tolerance ±0.004 (0.1)

PIN CONNECTION		
PIN	SINGLE	DUAL
1	+ INPUT	+ INPUT
2	- INPUT	- INPUT
3	ON/OFF	ON/OFF
4	+VOUT	+VOUT
5	TRIM	COMMON
6	-VOUT	-VOUT

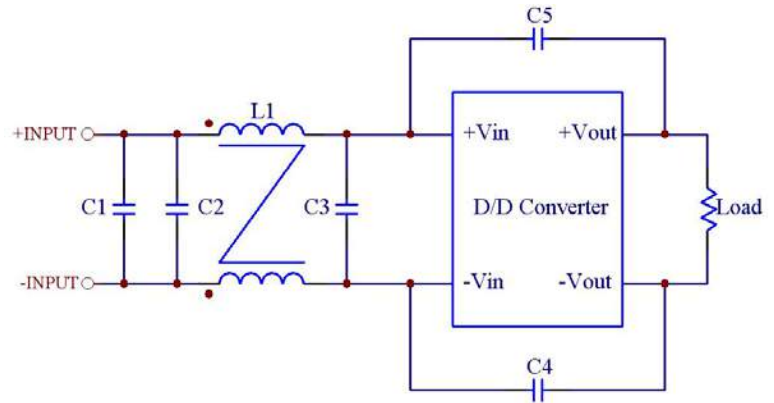

Recommended Filter for EN55022 Class B Compliance

The components used in the above figure, together with the manufacturers' part numbers for these components, are as follows:

	C1	C2	C3	C4 & C5	L1
LCD15-24xxxW	6.8µF/50V 1812 MLCC	N/A	6.8µF/50V 1812 MLCC	470pF/2KV 1808 MLCC	325µH Common Choke PMT-050
LCD15-48xxxW	2.2µF/100V 1812 MLCC	2.2µF/100V 1812 MLCC	2.2µF/100V 1812 MLCC	1000pF/2KV 1808 MLCC	325µH Common Choke PMT-050

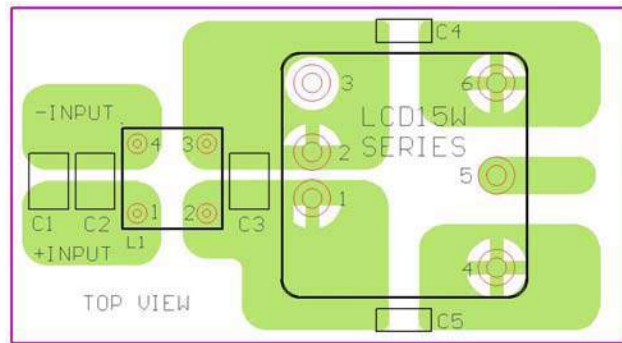

Recommended EN55022 Class B Filter Circuit Layout

EXTERNAL OUTPUT TRIMMING

Output can be externally trimmed by using the method shown below.

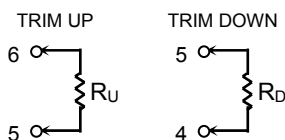

PRODUCT STANDARD TABLE

Option	Suffix
Negative remote ON/OFF(Standard)	
Positive remote ON/OFF without ON/OFF pin	-A
negative remote ON/OFF without TRIM pin without ON/OFF&TRIM pin	-C
positive remote ON/OFF without TRIM pin	-E